

WAGNER

2017 WEB EDITION

ALTERNATOR FRAMES

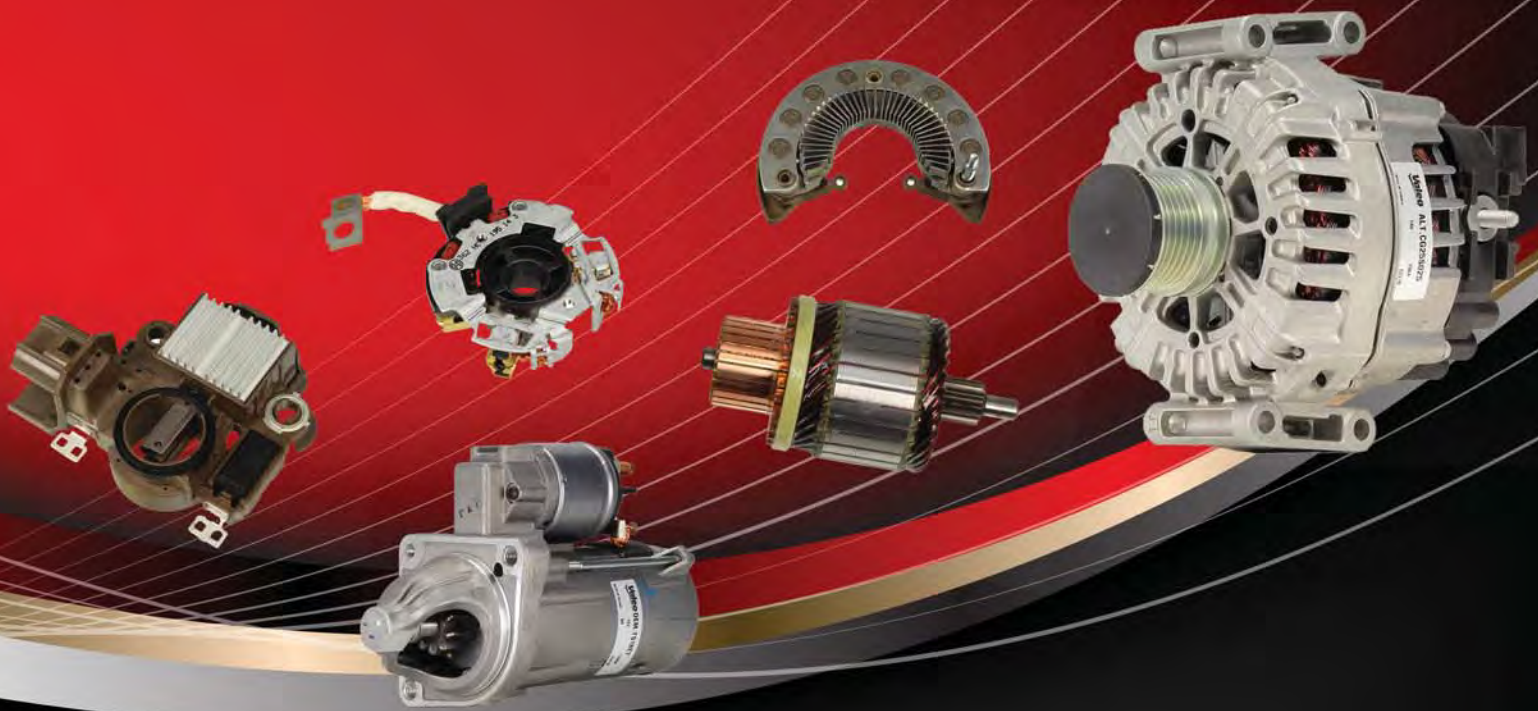

Helping You to Rebuild Tomorrow's World!



TERMS

CREDIT / PAYMENT TERMS

C.O.D. terms are cash or company check. Terms are C.O.D. until credit has been established by completing a credit application and being approved by WAGNER. An open account is Net 30 days from invoice date. Monthly statements will be mailed for your convenience.

Accounts exceeding 30 days are subject to 1.5% per month finance charge. Any account proceeding into 60 days past due status shall have all charge privileges suspended until account is paid in full, or at the discretion of management. Returned checks will be subject to a \$25.00 charge.

ORDER TERMS

Wagner Alternators & Supplies, Inc. reserves the right to accept any order or part thereof. **Orders under \$25 are subject to a \$5.00 special handling fee.**

SHIPPING TERMS

Merchandise is billed at the time of shipment. All prices are F.O.B., Chino, California, freight collect unless otherwise agreed in writing in advance by WAGNER. Orders are shipped via U.P.S., Federal Express, OnTrac or other common carriers unless otherwise specified at the time of order.

Shortages or incorrect merchandise must be reported within 10 days after receipt.

RETURNS

Any Return must be authorized in advance with a **RMA Number** and **must include** documentation of contents, original invoice number and reason for return. All boxes must have RMA number on outside of box. Returned merchandise may be subject to a 15% restocking charge and must be in the original box or package. **Unauthorized returns** are subject to 30% handling charge and/or return to customer.

LIMITED MANUFACTURER'S WARRANTY

Wagner's liability is limited to the repair, replacement or credit for the value of the product sold within one year of invoice date. If product is found to be defective, Wagner will not be responsible beyond the value of the defective piece, nor in any way be responsible for any damages or expenses caused by defective goods. Wagner is not responsible for any misuse of its products. Wagner will not be liable to replace any part which has been altered, defaced, modified, or treated in such a way the company finds unacceptable.

PRICING TERMS

Wagner Alternators & Supplies, Inc. will make every effort to keep its customers informed of any price changes. Wagner reserve the right to change prices without notice. From time to time, we may find it necessary to apply a surcharge occasionally to offset additional import costs. Any such charge will be noted on the invoice and we will do our best to inform the customer at the time the order is placed. All invoices reflect prices in effect at time of shipment.

Care is taken to ensure the accuracy of descriptions for each item, but Wagner assumes no responsibility for possible errors. **Permission to reproduce this catalog and/or contents is expressly denied.**

WAGNER NUMBERING SYSTEM

We have developed a simple yet efficient part numbering system that allows grouping of the electrical components by application (Alternator, Generator, or Starter), type of part (Rectifier, Brush, Solenoid, Etc.) and Manufacturer (Bosch, Lucas, Etc.).

EXAMPLE: W080-00H

The first letter signifies type of part:

W-Wagner Import Line	C- Chrysler
D-Delco	F-Ford
L-Leece Neville	M-Motorola
N-Nikko	P-Prestolite

The first two numerical digits represent the component classification:

ALTERNATOR

- 01-Alternator Covers
- 02-Bearings, Ball & Needle
- 03-Alternator Brushes
- 04-Diodes, Diode Trios
- 05-Pulleys
- 06-Rectifiers
- 07-Rotors
- 08-Int. Voltage Regulators
- 09-Ext. Voltage Regulators
- 10-Stators
- 11-Alternator Small Parts
- 12-Alternator CE Frames
- 13-Alternator DE Frame
- 14-Wire Harness/Repair Plugs
- 15-Brush Holders
- 16-Slip Rings
- 17-Ignition Modules
- 18-Grease/Paint/Supplies
- 19-Tools/Test Equipment

GENERATOR

- 26- Generator Armature
- 27-Generator Brushes
- 30-Gen CE Frame
- 31-Gen DE Frame

STARTER

- 40-Armatures
- 41-Starter Brushes
- 42-Bushings
- 45-Solenoids
- 46-Solenoid Caps
- 47-Starter Drives
- 48-Starter Small Parts
- 49-Starter CE Frame
- 50-Brush Holders
- 51-Housings
- 55-Testers

If a third digit shows, it represents the original Manufacturer in our Import line:

0 - Bosch	3 - Fiat, Magneti Marelli	6 - Motorola
1 - Lucas, Cav, Butec	4 - SEV	7 - Ducellier
2 - Paris Rhone, Valeo	5 - All Japanese	8 - Iskra









The final two numerical digits designate the specific identification number within each category. If the part number is not immediately followed by a letter, then it is an aftermarket replacement part.

Otherwise, one of the following may be used:

"N" Denotes Original OEM Part	"H" Denotes Hybrid
"S" Denotes Sold in Set	

Original Manufacturer names and numbers are used for reference purposes only.

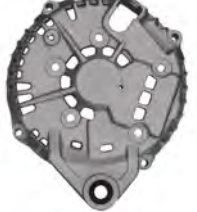

<p>HITACHI</p>  <p>W125-02 HITACHI ALTERNATOR SRE FRAME</p> <p>NISSAN</p> <p>13637</p> <p>LR170-743 LR170-748 LR170-748B</p> <p>126mm OD, 117.5mm ID, 10mm MOUNT, 27mm BEARING BORE SRE, W02X-31 BEARING, MATCHING DE FRAMES W135-02(13637)</p>	<p>HITACHI</p>  <p>W125-05 HITACHI INT FAN SRE FRAME</p> <p>NISSAN</p> <p>13760 13778</p> <p>LR1100-709B LR1100-709C LR170-766 LR170-766B</p> <p>134mm OD, 126mm STATOR, 10mm MOUNT, 27mm BEARING BORE SRE, W02X-31 BEARING, MATCHING DE FRAMES W135-09(13760)</p>	<p>HITACHI</p>  <p>W125-133 HITACHI ALTERNATOR SRE FRAME</p> <p>NISSAN</p> <p>11027</p> <p>LR1100-736C</p> <p>133mm OD, 126mm STATOR, 8mm MOUNT, 27mm BEARING BORE SRE, W02X-31 BEARING</p>
<p>HITACHI</p>  <p>W125-03 HITACHI INT FAN SRE FRAME</p> <p>HONDA ISUZU</p> <p>13564</p> <p>LR160-726 LR160-726B</p> <p>126mm OD, 117.5mm ID, 10mm MOUNT, 27mm BEARING BORE SRE, W02X-31 BEARING, MATCHING DE FRAMES W135-03(13564)</p>	<p>HITACHI</p>  <p>W125-12 HITACHI ALTERNATOR SRE FRAME</p> <p>HONDA ISUZU</p> <p>13935</p> <p>LR190-743</p> <p>135mm OD, 10mm MOUNT, 27mm BEARING BORE SRE, W02X-31 BEARING, MATCHING DE W135-62</p>	<p>HITACHI</p>  <p>W125-137 HITACHI ALTERNATOR SRE FRAME</p> <p>INFINITI NISSAN</p> <p>13612</p> <p>LR1125-702 LR1125-702B LR1125-702F</p> <p>146mm OD, 139mm STATOR, 10mm MOUNT, LONG BUSHING, 27mm BEARING BORE SRE, W02X-31 BEARING, MATCHING DE FRAME W135-08</p>
<p>HITACHI</p>  <p>W125-04 HITACHI INT FAN SRE FRAME</p> <p>NISSAN</p> <p>13827</p> <p>LR1100-722</p> <p>134mm OD, 126mm STATOR, 10mm MOUNT, 27mm BEARING BORE SRE, W02X-31 BEARING, MATCHING DE FRAMES W135-06</p>	<p>HITACHI</p>  <p>W125-122 HITACHI ALTERNATOR SRE FRAME</p> <p>INFINITI NISSAN</p> <p>11120</p> <p>LR1130-701 LR1130-701B</p> <p>146mm OD, 139/136mm STATOR, 27mm BEARING BORE, 10x1.25 thread mount SRE, W02X-31 BEARING</p>	<p>HITACHI</p>  <p>W125-138 HITACHI ALTERNATOR SRE FRAME</p> <p>NISSAN</p> <p>13639</p> <p>LR1110-705 LR1110-705B</p> <p>146mm OD, 139/136mm STATOR, 10mm MOUNT SHORT BUSHING, 27mm BEARING BORE SRE, W02X-31 BEARING, MATCHING DE FRAME W135-08</p>



HITACHI



W125-139
HITACHI ALTERNATOR SRE FRAME

MAZDA

13788 13895

LR170-758 LR180-766

134mm OD, 126mm STATOR, 10mm MOUNT, 27mm BEARING BORE
SRE, W02X-31 BEARING, MATCHING DE W135-128

HITACHI



W125-86
HITACHI ALTERNATOR SRE FRAME

NISSAN

13273

LR180-729

134mm OD, 126mm STATOR, 10mm MOUNT, 27mm BEARING BORE
SRE, W02X-31 BEARING, MATCHING DE FRAME W135-86

mitsubishi



W125-124
MITSUBISHI ALTERNATOR SRE FRAME

MITSUBISHI MOTOR

11055 11095 11118

A3TG1191 A3TG1192 A3TG2192AC
A3TG3491 A3TG4891ZC

140mm OD, 133/139mm STATOR, 10mm MOUNT, 100mm RECT, 23mm BEARING BORE
SRE, W02X-50 BEARING, DE FRAME W135-96

HITACHI



W125-18
HITACHI ALTERNATOR SRE FRAME

NISSAN

13940

LR1110-721

146mm OD, 139mm STATOR, 10mm MOUNT, 27mm BEARING BORE
SRE, W02X-31 BEARING, MATCHING DE FRAMES W135-08

MITSUBISHI



W125-06
MITSUBISHI ALTERNATOR SRE FRAME

MAZDA

13883

A3TB1081 A3TB1081A

139mm OD, 133mm STATOR, 12mm MOUNT, 23mm BEARING BORE, 100mm RECT
SRE, BEARING W02X-50, MATCHING DE FRAMES W135-10

MITSUBISHI



W125-13
MITSUBISHI ALTERNATOR SRE FRAME

CHRYSLER DODGE PLYMOUTH

13764 13955

A3TA4191ZC A3TB1691ZC

145mm OD, 133mm STATOR, 10mm MOUNT, 100mm RECT
SRE, W02X-50 BEARING, MATCHING DE FRAMES W135-46

HITACHI



W125-19
HITACHI ALTERNATOR SRE FRAME

NISSAN

13939

LR1100-734

146mm OD, 139mm STATOR, 10x1.25 THREAD MOUNT, 27mm BEARING BORE
SRE, W02X-31 BEARING, MATCHING DE FRAMES W135-59

MITSUBISHI



W125-11
MITSUBISHI ALTERNATOR SRE FRAME

CHEVROLET SUZUKI

13780 13781 13950

A5TA3891ZC A5TA4291 A5TA4291ZC
A5TA7291ZC

125mm OD, 10mm MOUNT, 75mm RECT, 23mm BEARING BORE
SRE, W02X-50 BEARING, MATCHING DE FRAMES W135-58

MITSUBISHI



W125-140
MITSUBISHI ALTERNATOR SRE FRAME









INFINITI NISSAN

13478

A2T33593A

132mm OD, 126mm STATOR, 10mm MOUNT, 85mm RECT, 23mm BEARING BORE
SRE, W02X-50 BEARING, MATCHING DE FRAMES W135-129



<p>MITSUBISHI</p>  <p>W125-20 MITSUBISHI ALTERNATOR SRE FRAME MITSUBISHI MOTOR</p> <p>13949 A3TB2891</p> <p>140mm OD, 133mm STATOR, 10x1.25 MOUNT, 100mm RECT, 23mm BEARING BORE SRE, W02X-50 BEARING, MATCHING FRAMES W135-48</p>	<p>MITSUBISHI</p>  <p>W125-45 MITSUBISHI ALTERNATOR SRE FRAME MITSUBISHI MOTOR</p> <p>11029 A3TB5291ZC</p> <p>140mm OD, 10mm MOUNT, 100mm RECT, 23mm BEARING BORE SRE, W02X-50 BEARING, MATCHING DE FRAMES W135-50</p>	<p>MITSUBISHI</p>  <p>W125-48 MITSUBISHI ALTERNATOR SRE FRAME MITSUBISHI MOTOR</p> <p>11028 11053 A3TB1791 A3TB5491</p> <p>140mm OD, 10mm MOUNT, 100mm RECT, 23mm BEARING BORE SRE, W02X-50 BEARING, MATCHING DE FRAMES W135-51</p>
<p>MITSUBISHI</p>  <p>W125-21 MITSUBISHI ALTERNATOR SRE FRAME ACURA HONDA</p> <p>13966 A2TB7591</p> <p>135mm OD, 8mm MOUNT, 85mm RECT, 23mm BEARING BORE SRE, W02X-50 BEARING, MATCHING DE FRAMES W135-44</p>	<p>MITSUBISHI</p>  <p>W125-46 MITSUBISHI ALTERNATOR SRE FRAME MAZDA</p> <p>11005 13996 A3TG0081 A3TG0091</p> <p>146mm OD, 12mm MOUNT, 100mm RECT, 23mm BEARING BORE SRE, W02X-50 BEARING, MATCHING DE FRAMES W135-52</p>	<p>MITSUBISHI</p>  <p>W125-49 MITSUBISHI ALTERNATOR SRE FRAME CHRYSLER DODGE MITSUBISHI MOTOR</p> <p>13929 A3TB2291ZC</p> <p>140mm OD, 133mm STATOR, 10mm MOUNT, 100mm RECT, 23mm BEARING BORE SRE, W02X-50 BEARING, MATCHING DE FRAMES W135-47</p>
<p>MITSUBISHI</p>  <p>W125-44 MITSUBISHI ALTERNATOR SRE FRAME SUBARU</p> <p>11024 A3TG2391ZC</p> <p>140mm OD, 8mm MOUNT, 100mm RECT SRE, W02X-50 BEARING, MATCHING DE FRAMES W135-55</p>	<p>MITSUBISHI</p>  <p>W125-47 MITSUBISHI ALTERNATOR SRE FRAME INFINITI NISSAN</p> <p>11051 11052 A3TB4291 A3TG0191</p> <p>140mm OD, 133mm STATOR, 10x1.25 THREAD MOUNT, 100mm RECT, 23mm BEARING BORE SRE, W02X-50 BEARING, MATCHING DE FRAMES W135-49</p>	<p>MITSUBISHI</p>  <p>W125-53 MITSUBISHI ALTERNATOR SRE FRAME FORD MERCURY</p> <p>11026 11543 A4TJ0181ZC A4TJ0182ZC</p> <p>147mm OD, 140mm STATOR, 23mm BEARING BORE SRE, W02X-50 BEARING, MATCHING DE FRAMES W135-57</p>



MITSUBISHI



W125-55
MITSUBISHI ALTERNATOR SRE FRAME

INFINITI

11004
A3TG0391

140mm OD, 133mm STATOR, 10x1.25 MOUNT, 100mm RECT, 23mm BEARING BORE
SRE, W02X-50 BEARING, MATCHING DE FRAMES W135-53

MITSUBISHI



W125-58
MITSUBISHI ALTERNATOR SRE FRAME

CHRYSLER DODGE

13995
A2TG0191ZC

140mm OD, 10mm MOUNT, 85mm RECT, 23mm BEARING BORE
SRE, W02X-50 BEARING, MATCHING DE FRAMES W135-45

MITSUBISHI



W125-64
MITSUBISHI ALTERNATOR SRE FRAME

MITSUBISHI MOTOR

13615 13692 13786

A3T14491 A3TA1191 A3TA0791 A3TA1191A A3TA0791A

140mm OD, 10x1.25mm MOUNT, 100mm RECT, 23mm BEARING BORE
SRE, W02X-50 BEARING, MATCHING DE FRAMES W135-66

MITSUBISHI



W125-56
MITSUBISHI ALTERNATOR SRE FRAME

MAZDA

11008 11174
A3TG1391A A3TG4791

146mm OD, 126mm STATOR, 10mm MOUNTS, 100mm RECT, 23mm BEARING BORE
SRE, W02X-50 BEARING, MATCHING DE FRAMES W135-54

MITSUBISHI



W125-59
MITSUBISHI ALTERNATOR SRE FRAME

MITSUBISHI MOTOR

11056
A3TG2291

140mm OD, 10x1.25 THREAD MOUNT, 100mm RECT, 32mm BEARING BORE
SRE, W02X-50 BEARING, MATCHING DE FRAMES W135-48

MITSUBISHI



W125-65
MITSUBISHI ALTERNATOR SRE FRAME

EAGLE MITSUBISHI MOTOR PLYMOUTH

13451
A2T38391

135mm OD, 126mm STATOR, 8mm MOUNT, 23mm BEARING BORE
SRE, W02X-50 BEARING, MATCHING DE FRAMES W135-79

MITSUBISHI



W125-57
MITSUBISHI ALTERNATOR SRE FRAME

MAZDA

11006
A3TJ0191

140mm OD, 12mm MOUNT, 23mm BEARING BORE
SRE, W02X-50 BEARING, MATCHING DE FRAMES W135-56

MITSUBISHI



W125-63
MITSUBISHI ALTERNATOR SRE FRAME

CHRYSLER

13892
A3TB2491

147mm OD, 133mm STATOR, 10mm MOUNT, 100mm RECT, 23mm BEARING BORE
SRE, W02X-50 BEARING, MATCHING DE FRAMES W135-65

MITSUBISHI







W125-66
MITSUBISHI ALTERNATOR SRE FRAME

MERCURY NISSAN

13821
A3TA5691ZC

140mm OD, 133mm STATOR, 8mm MOUNT, 100mm RECT, 23mm BEARING BORE
SRE, W02X-50 BEARING, MATCHING DE FRAMES W135-67



<p>MITSUBISHI</p>  <p>W125-67 MITSUBISHI ALTERNATOR SRE FRAME MITSUBISHI MOTOR</p> <p>13585</p> <p>A2T82791 A2T82792</p> <p>135mm OD, 126mm STATOR, 8mm MOUNT, 85mm RECT, 23mm BEARING BORE SRE, W02X-50 BEARING, MATCHING DE FRAMES W135-79</p>	<p>MITSUBISHI</p>  <p>W125-71 MITSUBISHI ALTERNATOR SRE FRAME MITSUBISHI MOTOR</p> <p>13750 13751 13787 13840 13898</p> <p>A2TA4991 A2TA5191 A2TA5391 A2TA5393ZC A2TB0892 A2TB5791ZC</p> <p>133mm OD, 126mm STATOR, 10mm MOUNT, 85mm RECT, 23mm BEARING BORE SRE, W02X-50 BEARING, MATCHING DE FRAMES W135-69(13787)</p>	<p>MITSUBISHI</p>  <p>W125-81 MITSUBISHI ALTERNATOR SRE FRAME MITSUBISHI MOTOR</p> <p>13716 13717</p> <p>A5TA0391 A5TA1891</p> <p>126mm OD, 8mm MOUNT, 23mm BEARING BORE SRE, W02X-50 BEARING, MATCHING DE FRAMES W135-78</p>
<p>MITSUBISHI</p>  <p>W125-69 MITSUBISHI ALTERNATOR SRE FRAME DODGE PLYMOUTH</p> <p>13735</p> <p>A2TB1491</p> <p>140mm OD, 126mm STATOR, 10mm MOUNT, 85mm RECT, 23mm BEARING BORE SRE, W02X-50 BEARING, MATCHING DE FRAMES W135-45</p>	<p>MITSUBISHI</p>  <p>W125-75 MITSUBISHI ALTERNATOR SRE FRAME CHRYSLER DODGE MITSUBISHI MOTOR</p> <p>13886</p> <p>A3TA7691 A3TA7692 A3TB3491ZC</p> <p>140mm OD, 133mm STATOR, 10mm MOUNT, 100mm RECT, 23mm BEARING BORE SRE, W02X-50 BEARING, MATCHING DE FRAMES W135-74</p>	<p>MITSUBISHI</p>  <p>W125-82 MITSUBISHI ALTERNATOR SRE FRAME SUBARU</p> <p>13406</p> <p>A3T08891</p> <p>140mm OD, 8mm MOUNT, 100mm RECT, 23mm BEARING BORE SRE, W02X-50 BEARING, MATCHING DE FRAMES W135-82</p>
<p>MITSUBISHI</p>  <p>W125-70 MITSUBISHI ALTERNATOR SRE FRAME EAGLE MITSUBISHI MOTOR</p> <p>13582</p> <p>A2T80491</p> <p>133mm OD, 126mm STATOR, 10mm MOUNT, 85mm RECT, 23mm BEARING BORE SRE, W02X-50 BEARING</p>	<p>MITSUBISHI</p>  <p>W125-78 MITSUBISHI ALTERNATOR SRE FRAME FORD KIA MAZDA</p> <p>13445 13559 13614 13650 13718 13719</p> <p>A2T33891 A2T33892 A2T39291 A2T39391 A2T80391 A2T83491 A2T83491A A2TA3991 A2TB0091</p> <p>130mm OD, 126mm STATOR, 10mm MOUNT, 85mm RECT, 23mm BEARING BORE SRE, W02X-50 BEARING, MATCHING DE FRAMES W135-68(13718)</p>	<p>MITSUBISHI</p>  <p>W125-85 MITSUBISHI ALTERNATOR SRE FRAME MAZDA</p> <p>13511</p> <p>A3T07592</p> <p>140mm OD, 133mm STATOR, 10x1.5 THREAD MOUNT, 100mm RECT, 23mm BEARING BORE SRE, W02X-50 BEARING, MATCHING DE FRAME W135-85</p>

MITSUBISHI



W125-87
MITSUBISHI ALTERNATOR SRE FRAME

CHRYSLER DODGE

22-8300

13577

A3T14292

140mm OD, 10mm MOUNT, 23mm BEARING BORE, 100mm RECTIFIER
SRE, W02X-50 BEARING, MATCHING DE FRAME W135-87

NIPPONDENSO



W125-07
NIPPONDENSO ALTERNATOR SRE FRAME

CHRYSLER DODGE JEEP

11063 11243 11294 11295 11296

421000-0141 421000-0142 421000-0300
421000-0301 421000-0304 421000-0480
421000-0541 421000-0542 421000-0560

135mm OD, 10x1.50mm THREAD MOUNT, 35mm BEARING BORE
SRE, W02X-20 BEARING, HAIRPIN, MATCHING DE FRAMES W135-11

NIPPONDENSO



W125-10
NIPPONDENSO ALTERNATOR SRE FRAME

CHRYSLER DODGE PLYMOUTH

22-8222

11117 13765 13766 13824 13842 13911

121000-4270 121000-4280 121000-4331
121000-4350 121000-4351 121000-4451
121000-4491

135mm OD, 10mm MOUNT, 35mm BEARING BORE
SRE, W02X-20 BEARING, MATCHING DE FRAMES W135-36

MITSUBISHI



W125-88
MITSUBISHI ALTERNATOR SRE FRAME

FORD MAZDA

13446 13460

A3T08491 A3T08591

140mm OD, 133mm STATOR, 101.25 THREAD MOUNT, 100mm RECT, 23mm BEARING BORE
SRE, W02X-50 BEARING, MATCHING DE FRAME W135-88

NIPPONDENSO



W125-08
NIPPONDENSO INT FAN SRE FRAME

LEXUS TOYOTA

11087

104210-3460

135mm OD, 11.5mm MOUNT, 3 EXTERNAL 6mm MOUNTS, 35mm BEARING BORE
SRE, W02X-20 BEARING, HAIRPIN, MATCHING DE FRAMES W135-12

NIPPONDENSO



W125-101
NIPPONDENSO ALTERNATOR SRE FRAME

TOYOTA

11194 11354

104210-8110 104210-8230

SRE, ODD HAIRPIN, MATCHING FRAME W135-121

MITSUBISHI



W125-92
MITSUBISHI ALTERNATOR SRE FRAME

HONDA

13648

A2TA2191

138mm OD, 126mm STATOR, 85mm RECTIFIER MOUNT, 23mm BEARING BORE
SRE, BEARING W02X-50, MATCHING DE FRAME W135-92

NIPPONDENSO



W125-09
NIPPONDENSO ALTERNATOR SRE FRAME

DODGE JEEP

22-8223

13822 13823 13834 13877 13906 13910

121000-3610 121000-3620 121000-3630
121000-3670 121000-3760 121000-3780
121000-3800

126mm OD, 10mm ID MOUNTING BUSHING 30mm L, 35mm BEARING BORE
SRE, W02X-20 BEARING, MATCHING DE FRAMES W135-34

NIPPONDENSO



W125-102
NIPPONDENSO ALTERNATOR SRE FRAME

LEXUS TOYOTA

11136 11137 11322 11323 11325 11326

104210-2080 104210-2140 104210-4470
104210-4471 104210-4571 104210-4740
104210-4750 104210-5510 104210-5511

134mm OD, 10x1.25 THREAD MOUNT, M8 THREAD ADJ, 35mm BEARING BORE
SRE, W02X-20 BEARING, HAIRPIN, MATCHING DE FRAME W135-102



NIPPONDENSO



W125-109

NIPPONDENSO ALTERNATOR SRE FRAME

CHEVROLET PONTIAC

11146 11156 11183 11237

104210-2160 104210-4560 104210-4990
104210-5070 104210-5380

134mm OD, 128mm STATOR, 11mm ID MOUNT X 30.4mm W
SRE, W02X-20 BEARING, MATCHING DE FRAME W135-104

NIPPONDENSO

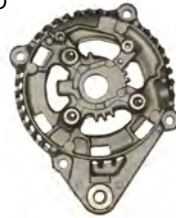

W125-14

NIPPONDENSO ALTERNATOR SRE FRAME

LEXUS TOYOTA

13558 13747 13755

101211-5620 101211-9600 101211-9780

125mm OD, 10x1.25 THREAD MOUNT, 35mm BEARING BORE
SRE, W02X-20 BEARING, MATCHING DE FRAME W135-61

NIPPONDENSO



W125-16

NIPPONDENSO ALTERNATOR SRE FRAME

JEEP

13907

121000-3810

125mm OD, 118mm STATOR, 10x1.5 THREAD MOUNT, 35mm BEARING BORE
SRE, W02X-20 BEARING, MATCHING FRAMES W135-33

NIPPONDENSO



W125-129

NIPPONDENSO ALTERNATOR SRE FRAME

VOLVO

11054 11093

104210-3560 104210-4050 104210-4051
104210-4640

135mm OD, 8mm MOUNT OVAL, 35mm BEARING BORE

SRE, W02X-20 BEARING, HAIRPIN, MATCHING W135-95

NIPPONDENSO



W125-141

NIPPONDENSO ALTERNATOR SRE FRAME

DODGE JEEP MITSUBISHI MOTOR

22-8226

13790 13873 13873C

121000-4250 121000-4251 121000-4400
121000-4410 121000-4440 121000-4540

137mm OD, 130mm STATOR, 35mm BEARING BORE

SRE, W02X-20 BEARING

NIPPONDENSO



W125-17

NIPPONDENSO ALTERNATOR SRE FRAME

ACURA HONDA

13918

104210-3090 104210-3091

136mm OD, 10mm MOUNT, 35mm BEARING BORE

SRE, HAIRPIN, W02X-20 BEARING, MATCHING DE FRAMES W135-22

NIPPONDENSO



W125-136

NIPPONDENSO ALTERNATOR SRE FRAME

FORD

11291

104210-5432

134mm OD, 13mm MOUNT

SRE, HAIRPIN, W02X-20 BEARING, MATCHING DE FRAME W135-127

NIPPONDENSO

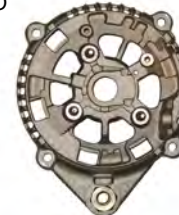

W125-15

NIPPONDENSO ALTERNATOR SRE FRAME

LEXUS

13956

101211-7440

137mm OD, 130mm STATOR, 10x1.25 THREAD MOUNT, 35mm BEARING BORE

SRE, W02X-20 BEARING, MATCHING DE FRAMES W135-14

NIPPONDENSO



W125-22

NIPPONDENSO ALTERNATOR SRE FRAME

DODGE JEEP

13912 13913

421000-0040 421000-0044 421000-0100
421000-0312

135mm OD, 10mm MOUNT, 10x1.50 THREAD MOUNT, 35mm BEARING BORE

SRE, W02X-20 BEARING, HAIRPIN, MATCHING DE FRAMES W135-40



NIPPONDENSO



W125-23

NIPPONDENSO ALTERNATOR SRE FRAME

CADILLAC PONTIAC

13919
104210-3060 104210-3070 104210-3330

135mm OD, 10mm MOUNT, 35mm BEARING BORE

SRE, W02X-20 BEARING, HAIRPIN, MATCHING DE FRAMES W135-20

NIPPONDENSO



W125-26

NIPPONDENSO ALTERNATOR SRE FRAME

TOYOTA

13959
101211-7400

140mm OD, 10x1.25 THREAD MOUNT, 35mm BEARING BORE

SRE, W02X-20 BEARING, HAIRPIN, MATCHING DE FRAMES W135-13

NIPPONDENSO



W125-29

NIPPONDENSO ALTERNATOR SRE FRAME

TOYOTA

13927
104210-3042

135mm OD, 10x1.25 THREAD MOUNT, 35mm BEARING BORE

SRE, W02X-20 BEARING, HAIRPIN, MATCHING DE FRAMES W135-19

NIPPONDENSO



W125-24

NIPPONDENSO ALTERNATOR SRE FRAME

DODGE

13914 13915
421000-0051 421000-0111 421000-0113

135mm OD, 10mm MOUNT, 35mm BEARING BORE

SRE, W02X-20 BEARING, HAIRPIN, MATCHING DE FRAMES W135-41

NIPPONDENSO



W125-27

NIPPONDENSO ALTERNATOR SRE FRAME

TOYOTA

13957 13958
102211-2120 102211-2480

125mm OD, 118mm STATOR, 10x1.25 THREAD MOUNT, 35mm BEARING BORE

SRE, W02X-20 BEARING, MATCHING DE FRAMES W135-17

NIPPONDENSO



W125-30

NIPPONDENSO ALTERNATOR SRE FRAME

ACURA

HONDA

13980
104210-3290 104210-3291 104210-4730
104210-4731 104210-4732

137mm OD, 8mm MOUNT, 35mm BEARING BORE

SRE, W02X-20 BEARING, HAIRPIN, MATCHING DE FRAMES W135-24

NIPPONDENSO



W125-25

NIPPONDENSO ALTERNATOR SRE FRAME

CHRYSLER DODGE

11039 11048 13923
421000-0120 421000-0180 421000-0190

135mm OD, 10mm MOUNT, 35mm BEARING BORE

SRE, W02X-20 BEARING, HAIRPIN, MATCHING DE FRAMES W135-42

NIPPONDENSO



W125-28

NIPPONDENSO ALTERNATOR SRE FRAME

JAGUAR

13925 13926
102211-0860 102211-0870

137mm OD, 130mm STATOR, 10mm MOUNT, 35mm BEARING BORE

SRE, W02X-20 BEARING, MATCHING DE FRAMES W135-16

NIPPONDENSO



W125-31

NIPPONDENSO ALTERNATOR SRE FRAME

ACURA









HONDA

13965 13977
102211-2670 102211-2680

125mm OD, 118mm STATOR, 8mm MOUNT, 35mm BEARING BORE

SRE, W02X-20 BEARING, MATCHING DE FRAMES W135-18



<p>NIPPONDENSO</p>  <p>W125-32 NIPPONDENSO ALTERNATOR SRE FRAME TOYOTA</p> <p>11152 104210-8010</p> <p>120mm OD, 10mm MOUNT</p> <p>SRE, W02X-20 BEARING, MATCHING DE FRAMES W135-32</p>	<p>NIPPONDENSO</p>  <p>W125-35 NIPPONDENSO ALTERNATOR SRE FRAME JAGUAR</p> <p>13909 102211-0520</p> <p>136mm OD, 130mm STATOR, 10mm MOUNT, 35mm BEARING BORE</p> <p>SRE, W02X-20 BEARING, MATCHING DE FRAMES W135-15</p>	<p>NIPPONDENSO</p>  <p>W125-38 NIPPONDENSO ALTERNATOR SRE FRAME LEXUS TOYOTA</p> <p>11032 11033 13981</p> <p>104210-3450 104210-3620 104210-3652 104210-3662 104210-3751 104210-3790 104210-4180 104210-4190</p> <p>137mm OD, 10x1.25mm THREAD MOUNT, 35mm BEARING BORE</p> <p>SRE, W02X-20 BEARING, HAIRPIN, MATCHING DE FRAMES W135-28(11032), W135-29(11033)</p>
<p>NIPPONDENSO</p>  <p>W125-33 NIPPONDENSO ALTERNATOR SRE FRAME JEEP</p> <p>11116 121000-4530</p> <p>137mm OD, 130mm STATOR, 10mm MOUNT, 10x1.25 MOUNT, 35mm BEARING BORE</p> <p>SRE, W02X-20 BEARING, MATCHING DE FRAMES</p>	<p>NIPPONDENSO</p>  <p>W125-36 NIPPONDENSO ALTERNATOR SRE FRAME JEEP</p> <p>13961 121000-4520</p> <p>136mm OD, 130mm STATOR, 10x1.50 THREAD MOUNT, 35mm BEARING BORE</p> <p>SRE, W02X-20 BEARING, MATCHING DE FRAME W135-37</p>	<p>NIPPONDENSO</p>  <p>W125-39 NIPPONDENSO ALTERNATOR SRE FRAME JAGUAR</p> <p>13979 104210-3081 104210-3082</p> <p>10mm MOUNT, 35mm BEARING BORE</p> <p>SRE, W02X-20 BEARING, HAIRPIN, MATCHING DE FRAMES W135-21</p>
<p>NIPPONDENSO</p>  <p>W125-34 NIPPONDENSO ALTERNATOR SRE FRAME DODGE</p> <p>13999 121000-3750</p> <p>124mm OD, 10x1.25 THREAD MOUNT</p> <p>SRE, W02X-20 BEARING, MATCHING DE FRAMES W135-33</p>	<p>NIPPONDENSO</p>  <p>W125-37 NIPPONDENSO ALTERNATOR SRE FRAME SCION TOYOTA</p> <p>11034 11084 11088 11195 11201</p> <p>104210-3780 104210-3880 104210-3890 104210-4030 104210-4790 104210-4810 104210-4811 104210-4881 104210-5330</p> <p>137mm OD, 10x1.25mm THREAD MOUNT</p> <p>SRE, W02X-20 BEARING, HAIRPIN, MATCHING DE FRAMES W135-30</p>	<p>NIPPONDENSO</p>  <p>W125-40 NIPPONDENSO ALTERNATOR SRE FRAME TOYOTA</p> <p>13984 104210-3470 104210-3471</p> <p>137mm OD, 10x1.25 THREAD MOUNT, 35mm BEARING BORE</p> <p>SRE, W02X-20 BEARING, HAIRPIN, MATCHING DE FRAMES W135-26</p>



NIPPONDENSO



W125-41

NIPPONDENSO ALTERNATOR SRE FRAME

ACURA HONDA SATURN

11030 11062 11099 11151 11392

104210-3100 104210-3500 104210-3770
104210-4480 104210-4690 104210-5910

137mm OD, 10mm MOUNT, 35mm BEARING BORE

SRE, W02X-20 BEARING, HAIRPIN, MATCHING DE FRAMES W135-27

NIPPONDENSO



W125-50

NIPPONDENSO ALTERNATOR SRE FRAME

CHRYSLER DODGE

11094

121000-4590

137mm OD, 130mm STATOR, 8mm MOUNT, 35mm BEARING BORE

SRE, W02X-20 BEARING, MATCHING DE FRAMES W135-39

NIPPONDENSO



W125-54

NIPPONDENSO ALTERNATOR SRE FRAME

CHRYSLER DODGE

11040 11244

421000-0150 421000-0371

137mm OD, 10mm MOUNT, 35mm BEARING BORE

SRE, W02X-20 BEARING, HAIRPIN, MATCHING DE FRAMES W135-41

NIPPONDENSO



W125-42

NIPPONDENSO ALTERNATOR SRE FRAME

BUICK PONTIAC

11035 11036

104210-3300 104210-3310

137mm OD, 10mm MOUNT, 35mm BEARING BORE

SRE, W02X-20 BEARING, HAIRPIN, MATCHING DE FRAMES W135-25

NIPPONDENSO



W125-51

NIPPONDENSO ALTERNATOR SRE FRAME

CHEVROLET PONTIAC SATURN

11109 11110 11140

104210-4140 104210-4330 104210-4420

136mm OD, 11mm MOUNT, 35mm BEARING BORE

SRE, W02X-20 BEARING, HAIRPIN, MATCHING DE FRAMES W135-31

NIPPONDENSO



W125-60

NIPPONDENSO ALTERNATOR SRE FRAME

LEXUS TOYOTA

13856

101211-7861

137mm OD, 130mm STATOR, 10mm MOUNT, M8 POST, M8 SIDE THREAD, 35mm BEARING BORE

SRE, W02X-20 BEARING, MATCHING DE FRAMES W135-63

NIPPONDENSO



W125-43

NIPPONDENSO ALTERNATOR SRE FRAME

CADILLAC

11003

104210-3280

137mm OD, 10x1.25mm MOUNTS, M6 HEAT SHIELD MOUNT

SRE, W02X-20 BEARING, HAIRPIN, MATCHING DE FRAMES W135-23

NIPPONDENSO



W125-52

NIPPONDENSO ALTERNATOR SRE FRAME

JEEP

13960

121000-3850

125mm OD, 118mm STATOR, 10x1.50mm THREAD MOUNT, 35mm BEARING BORE

SRE, W02X-20 BEARING, MATCHING DE FRAMES W135-35

NIPPONDENSO



W125-61

NIPPONDENSO ALTERNATOR SRE FRAME

DODGE

11297 11299 11378 11593 13988

421000-0210 421000-0212 421000-0512
421000-0521 421000-0730 421000-0790

137mm OD, 10x1.50 MOUNTS, 35mm BEARING BORE

SRE, W02X-20 BEARING, HAIRPIN, MATCHING DE FRAMES W135-43



NIPPONDENSO



W125-62
NIPPONDENSO ALTERNATOR SRE FRAME

CHRYSLER DODGE PLYMOUTH

22-8221

13593

121000-3520

125mm OD, 118mm STATOR, 10mm MOUNT 20mm L, 35mm BEARING BORE
SRE, W02X-20 BEARING. MATCHING DE FRAMES W135-34, SIMILAR TO W125-09

NIPPONDENSO



W125-73
NIPPONDENSO ALTERNATOR SRE FRAME

TOYOTA

13857

102211-1960

125mm OD, 118mm STATOR, 10x1.25mm THREAD MOUNT, 35mm BEARING BORE
SRE, W02X-20 BEARING, MATCHING DE FRAMES W135-71

NIPPONDENSO



W125-77
NIPPONDENSO ALTERNATOR SRE FRAME

TOYOTA

13385

100211-6110

137mm OD, 130mm STATOR, 10mm MOUNT, 35mm BEARING BORE
SRE, W02X-20 BEARING, MATCHING DE FRAMES W135-72(13385)

NIPPONDENSO



W125-68
NIPPONDENSO ALTERNATOR SRE FRAME

MINI COOPER

11049 23297

102211-2221 102211-2222 102211-2223
102211-2230 102211-2233

137mm OD, 130mm STATOR

SRE, W02X-20 BEARING, MATCHING DE FRAME W135-80

NIPPONDENSO



W125-74
NIPPONDENSO ALTERNATOR SRE FRAME

HONDA

13769

101211-7850 101211-7851

135mm OD, 130mm STATOR, 10mm MOUNT, 35mm BEARING BORE
SRE, W02X-20 BEARING, MATCHING DE FRAMES W135-73

NIPPONDENSO



W125-79
NIPPONDENSO ALTERNATOR SRE FRAME

CHRYSLER DODGE

13870 13871

421000-0011 421000-0012 421000-0013
421000-0021 421000-0023 421000-0026
421000-0028

135mm OD, 10mm MOUNT, 35mm BEARING BORE

SRE, W02X-20 BEARING, HAIRPIN, EARLY BRUSH HOLDER, MATCHING DE FRAMES W135-76

NIPPONDENSO



W125-72
NIPPONDENSO ALTERNATOR SRE FRAME

MAZDA

13759

101211-7240

137mm OD, 130mm STATOR, 10x1.25 THREAD MOUNT, 35mm BEARING BORE
SRE, W02X-20 BEARING, MATCHING DE FRAMES W135-70

NIPPONDENSO



W125-76
NIPPONDENSO ALTERNATOR SRE FRAME

FERRARI JAGUAR

11533 13524

100211-6310 101211-7540

137mm OD, 130mm STATOR, 10mm MOUNT, 35mm BEARING BORE
SRE, W02X-20 BEARING, MATCHING DE FRAMES W135-75(13524)

NIPPONDENSO



W125-80
NIPPONDENSO ALTERNATOR SRE FRAME

CHRYSLER DODGE

13868

421000-0060 421000-0061 421000-0062

135mm OD, 10mm MOUNT, 35mm BEARING BORE
SRE, W02X-20 BEARING, HAIRPIN, MATCHING DE FRAME W135-77



NIPPONDENSO



W125-83

NIPPONDENSO ALTERNATOR SRE FRAME

LEXUS TOYOTA

13384 13389 13553 13668 13715 13859

100211-6060 100211-6410 100211-6440
101211-7180 101211-7301 102211-0610

137mm OD, 130mm STATOR, 10mm MOUNT, 35mm BEARING BORE

SRE, W02X-20 BEARING, HEAT SHIELD MOUNT, MATCHING DE FRAMES W135-63

NIPPONDENSO



W125-91

NIPPONDENSO ALTERNATOR SRE FRAME

HONDA

22-8204

13509

100211-9770 101211-0250

126mm OD, 10mm MOUNT

SRE, W02X-20 BEARING, MATCHING DE FRAME W135-91

NIPPONDENSO



W125-95

NIPPONDENSO ALTERNATOR SRE FRAME

TOYOTA

11089 13794

101211-9590 104210-8000

126mm OD, 118mm STATOR, 10mm HOLE MOUNT, 35mm BEARING BORE

SRE, W02X-20 BEARING, MATCHING DE FRAME W135-94

NIPPONDENSO



W125-84

NIPPONDENSO ALTERNATOR SRE FRAME

CHRYSLER DODGE PLYMOUTH

22-8224

13592 13741

121000-4210 121000-4211 121000-4260

137mm OD, 130mm STATOR, 10mm MOUNT, 35mm BEARING BORE

SRE, W02X-20 BEARING, MATCHING DE FRAME W135-84

NIPPONDENSO



W125-93

NIPPONDENSO ALTERNATOR SRE FRAME

CHRYSLER DODGE

22-8225

13763 13964

121000-4231 121000-4232 121000-4233
121000-4372 121000-4373 121000-4580

137mm OD, 130mm STATOR, M10 x 1.5 THREAD MOUNT, 8mm EAR

SRE, W02X-20 BEARING

NIPPONDENSO



W125-89

NIPPONDENSO ALTERNATOR SRE FRAME

DODGE

13874

121000-4481

137mm OD, 10mm MOUNT, 35mm BEARING BORE

SRE, W02X-20 BEARING, MATCHING DE FRAME W135-36

NIPPONDENSO



W125-94

NIPPONDENSO ALTERNATOR SRE FRAME

ISUZU JOHN DEERE SUZUKI
TOYOTA

12354 12473 12778 12853 13680 13753
22836

102211-5020 102211-5060 102211-5061
102211-5070 102211-5120 102211-5121
102211-5151 102211-5160 102211-5161

118mm OD, 10mm MOUNT, 35mm BEARING BORE

SRE, W02X-20 BEARING

Disclaimer

Wagner Alternators & Supplies, Inc. shall have neither liability nor responsibility to any person or entity with respect to loss and/or damages caused or alleged to be caused directly or indirectly by information contained in this catalog or any other Wagner Alternators & Supplies, Inc. publication, web site or sales representative.

The user acknowledges that they assume all risk and/or responsibility for any loss or damage arising from the uses to which the information provided by this catalog. Every effort has been made to make this information as complete and accurate as possible. However, there may be mistakes both typographical and in content. The information herein has been obtained through reliable sources and to the best of our knowledge is correct in content.

Any original equipment manufacturers or other manufacturers, or distributors, whose names, numbers, pictures, symbols, products and/or descriptions are, or may be, listed or shown are used for reference purposes only and there is no representation made or intended, nor implied that any item reference herein is the product of, or was manufactured and/or distributed, by, the referenced manufacturer or distributor. This catalog does not recommend any particular brand or product and no endorsements are implied. All company names and their products herein are covered by Copyright or Registered Trade Marks. Any use of them can lead to legal action.

Notice

All rights are reserved. Copies of information, product flyers and catalogs may be printed only for use in the normal course of business, and only for in-house use. No copies, reprints, reproductions, digital scanning, recording, distribution or publishing of any materials found on this site are permitted without the express written permission from Wagner Alternators & Supplies, Inc.

Prepared in U.S.A.

Copyright © 2017 by Wagner Alternators & Supplies, Inc.