

WAGNER

2017 WEB EDITION

ALTERNATOR BRUSH HOLDERS



Helping You to Rebuild Tomorrow's World!



TERMS

CREDIT / PAYMENT TERMS

C.O.D. terms are cash or company check. Terms are C.O.D. until credit has been established by completing a credit application and being approved by WAGNER. An open account is Net 30 days from invoice date. Monthly statements will be mailed for your convenience.

Accounts exceeding 30 days are subject to 1.5% per month finance charge. Any account proceeding into 60 days past due status shall have all charge privileges suspended until account is paid in full, or at the discretion of management. Returned checks will be subject to a \$25.00 charge.

ORDER TERMS

Wagner Alternators & Supplies, Inc. reserves the right to accept any order or part thereof. **Orders under \$25 are subject to a \$5.00 special handling fee.**

SHIPPING TERMS

Merchandise is billed at the time of shipment. All prices are F.O.B., Chino, California, freight collect unless otherwise agreed in writing in advance by WAGNER. Orders are shipped via U.P.S., Federal Express, OnTrac or other common carriers unless otherwise specified at the time of order.

Shortages or incorrect merchandise must be reported within 10 days after receipt.

RETURNS

Any Return must be authorized in advance with a **RMA Number** and **must include** documentation of contents, original invoice number and reason for return. All boxes must have **RMA number** on outside of box. Returned merchandise may be subject to a 15% restocking charge and must be in the original box or package. **Unauthorized returns** are subject to 30% handling charge and/or return to customer.

LIMITED MANUFACTURER'S WARRANTY

Wagner's liability is limited to the repair, replacement or credit for the value of the product sold within one year of invoice date. If product is found to be defective, Wagner will not be responsible beyond the value of the defective piece, nor in any way be responsible for any damages or expenses caused by defective goods. Wagner is not responsible for any misuse of its products. Wagner will not be liable to replace any part which has been altered, defaced, modified, or treated in such a way the company finds unacceptable.

PRICING TERMS

Wagner Alternators & Supplies, Inc. will make every effort to keep its customers informed of any price changes. Wagner reserve the right to change prices without notice. From time to time, we may find it necessary to apply a surcharge occasionally to offset additional import costs. Any such charge will be noted on the invoice and we will do our best to inform the customer at the time the order is placed. All invoices reflect prices in effect at time of shipment.

Care is taken to ensure the accuracy of descriptions for each item, but Wagner assumes no responsibility for possible errors. **Permission to reproduce this catalog and/or contents is expressly denied.**

WAGNER NUMBERING SYSTEM

We have developed a simple yet efficient part numbering system that allows grouping of the electrical components by application (Alternator, Generator, or Starter), type of part (Rectifier, Brush, Solenoid, Etc.) and Manufacturer (Bosch, Lucas, Etc.).

EXAMPLE: W080-00H

The first letter signifies type of part:

W-Wagner Import Line	C- Chrysler
D-Delco	F-Ford
L-Leece Neville	M-Motorola
N-Nikko	P-Prestolite

The first two numerical digits represent the component classification:

ALTERNATOR

- 01-Alternator Covers
- 02-Bearings, Ball & Needle
- 03-Alternator Brushes
- 04-Diodes, Diode Trios
- 05-Pulleys
- 06-Rectifiers
- 07-Rotors
- 08-Int. Voltage Regulators
- 09-Ext. Voltage Regulators
- 10-Stators
- 11-Alternator Small Parts
- 12-Alternator CE Frames
- 13-Alternator DE Frame
- 14-Wire Harness/Repair Plugs
- 15-Brush Holders
- 16-Slip Rings
- 17-Ignition Modules
- 18-Grease/Paint/Supplies
- 19-Tools/Test Equipment

GENERATOR

- 26- Generator Armature
- 27-Generator Brushes
- 30-Gen CE Frame
- 31-Gen DE Frame

STARTER

- 40-Armatures
- 41-Starter Brushes
- 42-Bushings
- 45-Solenoids
- 46-Solenoid Caps
- 47-Starter Drives
- 48-Starter Small Parts
- 49-Starter CE Frame
- 50-Brush Holders
- 51-Housings
- 55-Testers

If a third digit shows, it represents the original Manufacturer in our Import line:

0 - Bosch	3 - Fiat, Magneti Marelli	6 - Motorola
1 - Lucas, Cav, Butec	4 - SEV	7 - Ducellier
2 - Paris Rhone, Valeo	5 - All Japanese	8 - Iskra

The final two numerical digits designate the specific identification number within each category. If the part number is not immediately followed by a letter, then it is an aftermarket replacement part.

Otherwise, one of the following may be used:

"N" Denotes Original OEM Part	"H" Denotes Hybrid
"S" Denotes Sold in Set	

Original Manufacturer names and numbers are used for reference purposes only.



BOSCH



W150-00
BOSCH ALTERNATOR BRUSH HOLDER

ALFA ROMEO	AUDI	AUSTIN
BMW	BOMAG	CARRARO

39-9100

13028	13033	13036	13039	13050	13054
13058	13071	13073	13077	13079	13100

0-120-300-522	0-120-300-528	0-120-300-529
0-120-300-531	0-120-300-532	0-120-300-535
0-120-300-536	0-120-300-537	0-120-300-538

32mm SLIP RING

BRUSHES W030-01, SPRINGS W110-56, REPAIR PLUG W140-01, HARNESS W140-02

BOSCH



W150-04
BOSCH ALTERNATOR BRUSH HOLDER

CHRYSLER	DODGE	PLYMOUTH
----------	-------	----------

39-9102 BH-B531

14789

0-120-450-011	0-120-450-012	0-120-450-013
0-120-450-014	0-120-450-016	0-120-450-017

4mm STUDS

F1-F2, EXTERNAL REGULATED, BRUSHES W030-02

BOSCH



W150-07
BOSCH ALTERNATOR BRUSH HOLDER

DODGE	JEEP
-------	------

39-9105 TB-B001

11314	13777	13843	13854	13881	13916
13917	13920				

0-124-425-001	0-124-525-002	0-124-525-004
0-124-525-005	0-124-525-007	6-004-MA5-001
6-004-ML0-000	6-004-ML0-001	6-004-ML0-002

F1-F2 PINS, 2.2uF CAPACITOR, BRUSHES W030-03, ALTERNATE W150-07N

BOSCH



W150-01
BOSCH ALTERNATOR BRUSH HOLDER

ALFA ROMEO	AUDI	BMW
BOMAG	CASE	DAF

13009 13014 13018 13027 13030 13031

13040 13043 13061 13069 13071 13079

0-120-400-600	0-120-400-614	0-120-400-620
0-120-400-621	0-120-400-622	0-120-400-623
0-120-400-624	0-120-400-625	0-120-400-626

3 PRONG PLUG

SPADE TERMINALS, BRUSHES W030-00, REPAIR PLUG W140-01, HARNESS W140-02

BOSCH



W150-05
BOSCH ALTERNATOR BRUSH HOLDER

DODGE	PLYMOUTH
-------	----------

39-9101 BH-B521

14787

0-120-400-944	0-120-400-945
---------------	---------------

1/4" D+ SPADE, 3/16" DF SPADE

EXTERNAL REGULATED, BRUSHES W030-02

BOSCH



W150-07N
BOSCH ALTERNATOR BRUSH HOLDER

DODGE	JEEP
-------	------

39-9105 TB-B001

11314	13777	13843	13854	13872	13881
13916	13917	13920			

0-124-425-001	0-124-525-002	0-124-525-003
0-124-525-004	0-124-525-005	0-124-525-007
6-004-MA5-001	6-004-ML0-000	6-004-ML0-001

F--F2, 2.2uF CAPACITOR, BRUSHES W030-03, ALTERNATE W150-07

BOSCH



W150-02
BOSCH ALTERNATOR BRUSH HOLDER

VOLVO

13011 13038

0-120-400-604	0-120-400-605	0-120-400-756
0-120-400-757		

1/4" SPADE

BRUSHES W030-00

BOSCH



W150-06
BOSCH ALTERNATOR BRUSH HOLDER

CHRYSLER	DODGE	PLYMOUTH
----------	-------	----------

39-9104

13315

0-120-450-018	0-120-450-019	0-120-450-020
0-120-450-023	0-120-450-024	0-120-450-025

BRUSHES W030-02.

BOSCH



W150-08
BOSCH ALTERNATOR BRUSH HOLDER

DODGE

39-9106

11235	13985	13987
-------	-------	-------

0-124-525-006	0-124-525-041	0-124-525-051
0-124-525-105		

F1-F2 PINS, 2.2uF CAPACITOR, BRUSHES W030-03, ALTERNATE W150-08N OEM

BOSCH



W150-08N
BOSCH ALTERNATOR BRUSH HOLDER

DODGE

11235 13985 13987

0-124-525-006 0-124-525-041 0-124-525-051
0-124-525-105

F1-F2 PINS, 2.2uF CAPACITOR, BRUSHES W030-03

CHRYSLER



C15-00
CHRYSLER ALTERNATOR BRUSH HOLDER

CHRYSLER DODGE PLYMOUTH

39-3201

7024 7505 7509 7537 7546 7549

3755404 3755406 3755407
3755411 3755413 3755441
3755444 3755447 3874695

COMMON CHRYSLER ROUND BACK, SQUARE BACK

DAEWOO
DELCO



D15-11
DAEWOO BRUSH HOLDER-CS121D

CHEVROLET DAEWOO

22732 8005 8280 8282

96190262 96221945 96224431
96252115 96252547 96258990
96288095 96303550 96303556

12V, CS121D

BOSCH



W150-09
BOSCH ALTERNATOR BRUSH HOLDER

DODGE

39-9107

11233 11235 11239 11280

0-124-525-110 0-124-525-111 0-124-525-129
0-124-525-154 0-124-525-155 0-124-525-156

14mm SLIP RING

SENSE(F1)-F2, PCM, 2.2uF, CAPACITOR, BRUSHES W030-03

CHRYSLER



C15-01
CHRYSLER ALTERNATOR BRUSH HOLDER

CHRYSLER DODGE PLYMOUTH

39-3203

7521

3755585 4091002 4091460
4091461

FOR 100 AND 114 AMP UNITS

DAEWOO
DELCO



D15-12
DELCO BRUSH HOLDER

SATURN

39-111 39-111-3

8232

21022992 21023969 21024485
21024727

12V, BRUSHES D03-14, D03-15, NOTICE THE FIELD CONNECTION LOCATION, SEE D15-11

BOSCH



W150-09N
BOSCH ALTERNATOR BRUSH HOLDER

DODGE

39-9107

11233 11235 11239 11280

0-124-525-110 0-124-525-111 0-124-525-129
0-124-525-154 0-124-525-155 0-124-525-156

14mm SLIP RING

SENSE(F1) -F2, 2.2uF CAPACITOR, BRUSHES W030-03

CHRYSLER



C15-02
CHRYSLER ALTERNATOR BRUSH HOLDER

CHRYSLER DODGE PLYMOUTH

39-3200

7004 7006 7007 7024 7505 7509

2095000 2095060 2095100
2095300 2095661 2095663
2095666 2095667 2098260

6mm OD BRUSH

ROUND BACK UNITS, C03-00, C03-01, C03-05, C03-06

DELCO



D15-00
DELCO ALTERNATOR BRUSH HOLDER

ALLIS-CHALMERS BAKER AMC BUICK AUSTIN WESTERN CADILLAC

39-100

7106 7107 7111 7116 7122 7141
7143 7144 7146 7149 7151 7156

1100059 1100062 1100063
1100064 1100065 1100066
1100067 1100068 1100071

10DN, FOR HOLDER ONLY D15-03



DELCO



D15-01
DELCO ALTERNATOR BRUSH HOLDER

AMC CHEVROLET	BUICK GMC	CADILLAC IH (INTERNATIONAL
------------------	--------------	-------------------------------

39-103

7134-12	7134-3	7134-6	7134-6R	7134-9	7134-9R
7134-R	7137-12	7137-3	7137-6	7137-6R	7137-9
10479825	10479826	10479833			
10479858	10479860	10479862			
10479865	10479867	1100183			

15Si, 17Si SERIES. BRUSHES D03-06, SPRINGS D11-31 INCLUDED, SEE D15-02

DELCO



D15-05
DELCO ALTERNATOR BRUSH HOLDER

BUICK GMC	CADILLAC ISUZU	CHEVROLET OLDSMOBILE
--------------	-------------------	-------------------------

39-109 39-109-1 BHRA003

8155-3	8156-3	8158-5	8160-11	8160-5	8160-7
8190-11	8197-7	8199-2	8200-11	8206-5	8208-2
10437987	10437988	10447094			
10447095	10447096	10447097			
10449257	10479981	10479984			

35mm ID BEARING RETAINER

CS130D, SHORT POSITIVE CLIP, SIMILAR TO D15-06 AND IS ALTERNATIVE, BRUSHES D03-10, D03-11

DELCO



D15-08
DELCO BRUSH HOLDER-DR44G

BUICK CUMMINS	CADILLAC FREIGHTLINER	CHEVROLET GM
------------------	--------------------------	-----------------

39-113

8292	8301	8302	8489	8497	8498
8499	8540	8550	8700	8701	8702
10392759	15200109	15200110			
15200268	15225928	15288860			
15845337	15845338	15857608			

12V, DR44G, DR37, 24Si, SERIES, BRUSHES D03-10, D03-11

DELCO



D15-02
DELCO ALTERNATOR BRUSH HOLDER

BUICK GMC	CADILLAC IH (INTERNATIONAL	CHEVROLET JEEP
--------------	-------------------------------	-------------------

39-1202

7134-12	7134-9	7137-12	7137-3	7137-6	7137-9
7191-6	7192-12	7287-12	7287-3	7287-6	7287-9
10479825	10479826	10479833			
10479858	10479860	10479862			
10479865	10479867	1100271			

15Si, 17Si SERIES. HOLDER ONLY. FOR COMPLETE SET D15-01, BRUSHES D03-06, SPRINGS D11-31

DELCO



D15-06
DELCO ALTERNATOR BRUSH HOLDER

ACURA	HONDA
-------	-------

8220

10480228 10480228A

35mm ID BEARING RETAINER

CS130D, POSITIVE CLIP IS LONGER, SIMILAR TO D15-05 AND IS ALTERNATIVE

DELCO



D15-09
DELCO BRUSH HOLDER-CS130

BUICK DODGE	CADILLAC EAGLE	CHEVROLET GEO
----------------	-------------------	------------------

39-106

7687	7801-11	7801-3	7801-7	7802-11	7802-3
7802-7	7803-7	7804-11	7807-11	7808-3	7808-7
10479800	10479801	10479802			
10479805	10479806	10479807			
10479808	10479814	10479815			

12V, DELCO CS121, CS130 SERIES, BRUSHES D03-01, D03-02

DELCO



D15-03
DELCO BRUSH HOLDER

ALLIS-CHALMERS BAKER	AMC BUICK	AUSTIN WESTERN CADILLAC
-------------------------	--------------	----------------------------

39-1206

7106	7107	7111	7116	7122	7141
7143	7144	7146	7149	7151	7156
1100059	1100062	1100063			
1100064	1100065	1100066			
1100067	1100068	1100071			

10DN, HOLDER ONLY, FOR COMPLETE SET SEE D15-00

DELCO



D15-07
DELCO ALTERNATOR BRUSH HOLDER

BUICK GMC	CADILLAC ISUZU	CHEVROLET OLDSMOBILE
--------------	-------------------	-------------------------

39-112

8156-3	8235	8237	8238	8241	8244
8245	8247	8273	8274	8277	8278
10311493	10333165	10333166			
10343535	10346705	10442782			
10442783	10480229	10480234			

AD SERIES, PIN STYLE, BLACK, BRUSHES D03-10 D03-11

DELCO



D15-10
DELCO BRUSH HOLDER-22Si

CUMMINS FREIGHTLINER	FORD INTERNATIONAL	FORD H.D. KENWORTH
-------------------------	-----------------------	-----------------------

39-110 39-110-1 39-110-2

8070	8071	8072	8073	8074	8075
8076	8078	8079	8360	8361	8366
19020300	19020302	19020303			
19020304	19020305	19020306			
19020307	19020308	19020309			

12/24V, DELCO 22Si



DAEWOO
DELCO



D15-11
DAEWOO BRUSH HOLDER-CS121D

CHEVROLET DAEWOO

22732	8005	8280	8282
-------	------	------	------

96190262	96221945	96224431
96252115	96252547	96258990
96288095	96303550	96303556

12V, CS121D

FORD



F15-00
FORD ALTERNATOR BRUSH HOLDER 1G

AMC FORD JEEP
LINCOLN MERCURY

39-2200

7058	7076	7078	7083	7706
------	------	------	------	------

C7TF-10300-C	D2DF-10300-AC	D2OF-10300-BB
D2OF-10300-CB	D2OF-10300-EB	D2OF-10300-FB
D2TZ-10346-B	D2ZF-10300-AB	D2ZF-10300-AC

1G SERIES, BRUSHES F03-01, F03-02

HITACHI



W155-00
HITACHI ALTERNATOR BRUSH HOLDER

NISSAN

39-8101	IHB201
---------	--------

14255

LR150-31	LR150-35	LR150-36
LR150-50	LR150-51	LR150-52
LR150-53	LR150-58	W085-16

WITHOUT DIODE TRIO, FOR REGULATOR USE W085-01, FOR BRUSHES W035-00

DAEWOO
DELCO



D15-12
DELCO BRUSH HOLDER

SATURN

39-111	39-111-3
--------	----------

8232

21022992	21023969	21024485
21024727		

12V, BRUSHES D03-14, D03-15, NOTICE THE FIELD CONNECTION LOCATION, SEE D15-11

FORD



F15-01
FORD ALTERNATOR BRUSH HOLDER

FORD FORD H.D. LINCOLN
MAZDA MERCURY

39-207	39-207-1	39-207-3
--------	----------	----------

7748	7749-11	7749-3	7750	7751	7752
7753	7755-11	7755-3	7756-3	7756-7	7760

1L5U-10300-BA	1L5U-10300-BB	2C6U-10300-AB
2L3U-10300-BB	4L2T-10300-DB	4L2T-10300-DD
5C3T-10300-AA	5C3T-10300-AC	5L2T-10300-AA

NON THREADED FOR SELF TAPPING SCREWS LIKE OE

12V, 3G SERIES, FOR BRUSHES USE F03-08

HITACHI



W155-01
HITACHI ALTERNATOR BRUSH HOLDER

NISSAN

39-8102	IHB203
---------	--------

14185

LR160-42B

WITH DIODE TRIO, FOR REGULATOR USE W085-01, FOR BRUSHES USE W035-00.

DUCELLIER



W157-00
DUCELLIER ALTERNATOR BRUSH HOLDER

DELOREAN RENAULT

14324	14327	14329	14582	14959	14984
-------	-------	-------	-------	-------	-------

516006A	516006B	516008B
516009A	516009B	516020A
516020B	516025A	516025B

BRUSH HOLDER AND BRUSHES ONLY. COMPLETE WITH REGULATOR W087-00, REGULATOR W087-01, BRUSHES W037-00 & W037-01

FORD



F15-02
FORD VISTEON BRUSH HOLDER

FORD MAZDA

39-208

8439	8440	8538
------	------	------

1S7T-10300-AA	1S7T-10300-BC	1S7T-10300-BD
5C4O-10300-AB	5C4O-10300-AC	6E7O-10300-AA
6E7O-10300-AC		

12V, VISTEON, WITH BRUSHES

HITACHI



W155-06
HITACHI ALTERNATOR BRUSH HOLDER

CHEVROLET FORD ISHIKAWAJIMA
NEW HOLLAND NISSAN

39-8100

12106	12128	14105	14118	14119	14202
14214	14240				

LT115-52	LT120-07	LT130-81
LT130-89	LT135-13B	LT135-16
LT135-17B	LT135-19C	LT135-35

1/4" SPADE

FOR BRUSHES USE W035-00 OR W035-12, SPRINGS W115-151, MOUNTING SCREWS W115-44



HITACHI



W155-07
HITACHI ALTERNATOR BRUSH HOLDER

CHEVROLET ISUZU NISSAN
PONTIAC

39-8105

12118 12119 14613 14615 14645 14648
14649 14731

LR140-112 LR140-130B LR140-131
LR150-133B LR150-133C LR150-133E
LR150-146C LR150-147B LR150-155B

FOR BRUSHES USE W035-05, COMMONLY USED WITH UNITS WITH VACUUM PUMPS

HITACHI



W155-13
HITACHI ALTERNATOR BRUSH HOLDER

SUBARU

39-8109

13275

LR170-732B LR170-732C

FOR BRUSHES USE W035-18.

HITACHI



W155-16
HITACHI ALTERNATOR BRUSH HOLDER

NISSAN

39-8112

13477

LR195-701

FOR BRUSHES USE W035-19, FOR NOISE SUPPRESSOR USE W115-121, USE WITH REGULATOR W085-119.

HITACHI



W155-11
HITACHI ALTERNATOR BRUSH HOLDER

NISSAN

39-8110 39-8110-1

13333 13334 13474

LR165-708C LR170-738 LR170-738C
LR170-738E LR170-744 LR180-731B
LR180-738B

FOR BRUSHES USE W035-18, USED WITH REGULATOR W085-103.

HITACHI



W155-14
HITACHI ALTERNATOR BRUSH HOLDER

NISSAN

39-8114

13329 13474 13531 13533 13534 13535

LR160-724 LR170-739B LR180-725B
LR180-725C LR180-725E LR180-733
LR180-733B LR180-734B LR180-734C

FOR BRUSHES USE W035-18, USED WITH REGULATOR W085-113

HITACHI



W155-17
HITACHI ALTERNATOR BRUSH HOLDER

INFINITI

39-8113

13261

LR1100-702 LR1110-701 LR1110-702

FOR BRUSHES USE W035-19, FOR NOISE SUPPRESSOR W115-120.

HITACHI



W155-12
HITACHI ALTERNATOR BRUSH HOLDER

INFINITI NISSAN

39-8108

13273 13285 13287 13329 13533

LR160-723 LR160-723B LR170-734B
LR170-739 LR180-725 LR180-729

FOR BRUSHES USE W035-18, USED WITH REGULATOR W085-84.

HITACHI



W155-15
HITACHI ALTERNATOR BRUSH HOLDER

HONDA ISUZU NISSAN

39-8111

13334 13564 14859 14960

LR150-711 LR160-725 LR160-726
LR160-726B LR170-738B

FOR BRUSHES USE W035-18, USED WITH W085-101, W085-118

HITACHI



W155-18
HITACHI ALTERNATOR BRUSH HOLDER

INFINITI NISSAN

39-8116 BH-H02

13636 13637 13638 13640 13643 13644
13713 13724 13728 21265

LR1100-704 LR1100-704B LR1100-712
LR160-727 LR170-745 LR170-746E
LR170-748 LR170-748B LR180-741H

FOR BRUSHES USE W035-20.



HITACHI



W155-21
HITACHI ALTERNATOR BRUSH HOLDER

HONDA	INFINITI	ISUZU			
JOHN DEERE	NISSAN	SUBARU			

39-8118

12332	13612	13639	13641	13642	13645
13657	13712	13744	13745	13757	13775
LR1100-703	LR1100-705C	LR1100-711			
LR1110-705	LR1110-705B	LR1110-707E			
LR1125-702	LR1125-702B	LR160-725C			

FOR BRUSHES USE W035-20

LEECE-NEVILLE



L15-00
LEECE NEVILLE ALTERNATOR BRUSH HOLDER

DODGE	DRESSER	FORD H.D.			
FREIGHTLINER	IH (INTERNATIONAL)	INTERNATIONAL			

39-5200 BH-LN01 LB79030

7302	7602	7603	7604	7605	7606
7608	7610	7611	7612	7613	8503
2300J		2300JC		2301J	
2302J		2302JB		2303J	
2304J		2360J		2360JC	

JB SERIES, L03-00 BRUSHES

LUCAS



W151-02
CAV ALTERNATOR BRUSH HOLDER

PERKINS	ROLLS ROYCE		
---------	-------------	--	--

14076 14077 14078

1260A030 1260A288 AC5B12-53
AC5B12-63 AC5B12-6M

FOR EARLY BOLT BRUSHES USE W031-04.

HITACHI



W155-23
HITACHI ALTERNATOR BRUSH HOLDER

NISSAN

39-8104

14231

LR135-44 LR135-61 LR138-01

90mm

SMALLER THAN W155-00

LUCAS



W151-00
LUCAS ALTERNATOR BRUSH HOLDER

AUSTIN	FORD	JAGUAR			
LOTUS	MASSEY FERGUSO	MERCURY			

12038	12039	12043	12152	13146	13163
13164	14013	14014	14019	14022	14023
23562A/D		23563A		23565A/B	
23566A		23572A		23581A/E	
23582A		23584A		23589A/D	

FOR BRUSHES USE W031-00 AND OR W031-01.

MANDO VALEO



W155-28
MANDO ALTERNATOR BRUSH HOLDER

BOBCAT	KUBOTA	MELROE
MERCURY MARINE	OMC	PLEASURE CRAFT

12174 12175

AR150AA AR150BA AR150CA
AR150DA

12V, AR SERIES ALTERNATORS

HITACHI



W155-25
HITACHI ALTERNATOR BRUSH HOLDER

UD-NISSAN

BH-H01

LR170-502C

WITH GASKET, VERY SIMILAR TO W155-16 WITH DIFFERENT EYELET LOCATIONS, BRUSHES W035-20

LUCAS



W151-01
LUCAS ALTERNATOR BRUSH HOLDER

CASE	FIAT	FORD			
IH (INTERNATIONAL)	JAGUAR	LANDROVER			

12038	12039	12040	12041	12047	12073
12143	12152	12286	13145	13146	13163
23970A/B		23971A		23996A	
24011A		24027A/B		24037A/B	
24041A/F		24049A		24055A/B	

FOR BRUSHES USE W031-05S

MARELLI



W153-00
MARELLI ALTERNATOR BRUSH HOLDER

FIAT	LANCIA		
------	--------	--	--

13075 13131 13132 14045

4152101 4152612 63303140
63303150 63303213 63303280
63303300 63303311 63303360
1 PIN, 67

BRUSHES W033-00 & W033-01



MITSUBISHI



W155-19
MITSUBISHI ALTERNATOR BRUSH HOLDER

CHRYSLER	DODGE	PLYMOUTH
----------	-------	----------

39-8301 IMB735

13735 13892 13995

A2TB1491 A2TB2791 A2TG0191ZC
 A2TG0491ZC A3TB2491 A3TB2492

F1-F2. FOR BRUSHES USE W035-09, WITH CAPACITOR, REAR SHIELD AND GASKET

MITSUBISHI



W155-27
MITSUBISHI BRUSH HOLDER

CHRYSLER	DODGE	JEEP
----------	-------	------

39-8304 TB-M146

11228 11229 11231

A2TJ0481ZC A3TJ1881ZC A3TJ2581ZC

23mm SLIP RING, 0.45uF CAPACITOR

12V, F-B PLUG, W035-21 BRUSHES

MITSUBISHI



W155-31
MITSUBISHI BRUSH HOLDER

DODGE	JEEP
-------	------

TB-M001

11440 11477 11553 11554 11638

A2TL0381ZC A2TX0281 A2TX3481ZC
 A2TX3581ZC A3TX0391ZC

23mm SLIP RING, 2.2uF CAPACITOR

12V, F-B PLUG, W035-21 BRUSHES

MITSUBISHI



W155-20
MITSUBISHI ALTERNATOR BRUSH HOLDER

CHRYSLER	DODGE	EAGLE
MITSUBISHI MOTOR	PLYMOUTH	

39-8300 BH-M01 IM838

13575 13577 13580 13595 13764 13955

A2T81192 A2T81291 A2T81292
 A2T81391 A2TA3791 A2TA7491
 A3T14292 A3TA4191ZC A3TA7891ZC

F1-F2 CONNECTION, 1.0uF CAPACITOR, FOR BRUSHES USE W035-09, W035-21

MITSUBISHI



W155-27A
MITSUBISHI BRUSH HOLDER

CHRYSLER	DODGE	JEEP
----------	-------	------

11228 11229 11231

A2TJ0481ZC A3TJ1881ZC A3TJ2581ZC

23mm SLIP RING, 0.46uF CAPACITOR

12V, B-CIRCUIT, F-B PLUG, W035-21 BRUSHES, ALTERNATE W155-27

MOTOROLA VALEO



494488
VALEO BRUSH HOLDER

AIFO	IVECO	JOHN DEERE
MASSEY FERGUSO	MERCEDES HD	NEW HOLLAND

14327 14329 14388 14582 14610 14954

2541423 2940090 9AL2689K
 9AL2924K 9AR2659K 9AR2660K
 9AR2690P 9AR2760K 9AR2815K

1/4" FIELD SPADE, 1/4" D- SPADE

12/24V, B-CIRCUIT, GROUNDED 1/4" SPADE, BRUSHES W036-00, SPRINGS W036-00S, CAN REPLACE MOST ALL

MITSUBISHI



W155-26
MITSUBISHI ALTERNATOR BRUSH HOLDER

CHRYSLER

11230

A2TG0791ZC

B+ DF, B-CIRCUIT, BRUSHES W035-21, W035-09

MITSUBISHI



W155-30
MITSUBISHI TERMINAL BLOCK

CHRYSLER

11115

A3TJ0381ZC

23mm SLIP RING

12V, A-CIRCUIT, F1-F2 PLUG, W035-21 BRUSHES, W115-218 CAPACITOR

MOTOROLA VALEO



W156-00
MOTOROLA ALTERNATOR BRUSH HOLDER

ALLIS-CHALMERS	AUDI	AUSTIN
BMW	CARRIER	CASE

39-402

12103 12120 12121 12122 12143 12172
 12173 12289 12290 12304 12306 12307

2518032 2518033 2518035
 2518073 2518074 2541128
 2541129 2541130 2541131

USED ALSO ON VALEO ALTERNATORS, FOR BRUSHES USE W036-00, FOR SPRING USE W036-00S



MOTOROLA
VALEO

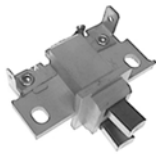

W156-01

MOTOROLA ALTERNATOR BRUSH HOLDER

BAUDOIN MARINE CHRYSLER	BMW DAF	BMW MARINE FARYMANN			
12154	12155	12292	12395	12397	12398
12399	12401	12402	12403	12405	12406
2518099	2940020	2940208			
2940753	2940754	2940926			
9AR2710P	9AR2712P	9AR2734P			

ISOLATED BRUSH FROM GROUND, FOR BRUSHES USE W036-00, FOR SPRING USE W036-00S

NIPPONDENSO



W155-04B

NIPPONDENSO ALTERNATOR BRUSH HOLDER

ACURA CATERPILLAR	BOBCAT CHEVROLET	CASE CUB CADET			
39-8200	BH-ND01	INB220			
11587	11748	12080	12081	12179	12180
12181	12182	12183	12185	12187	12188
100211-1001	100211-1030	100211-1031			
100211-1041	100211-1050	100211-1061			
100211-1071	100211-1080	100211-1081			

BRUSH HOLDER ONLY, FOR BRUSHES USE W035-04, FOR GROMMET USE W115-22, W115-22-1, SPRINGS W115-219

NIPPONDENSO



W155-08B

NIPPONDENSO ALTERNATOR BRUSH HOLDER

CHRYSLER JEEP	DODGE MITSUBISHI MOTOR	EAGLE PLYMOUTH			
11094	11116	11117	11242	13184	13185
13245	13256	13280	13301	13302	13304
121000-3000	121000-3100	121000-3200			
121000-3300	121000-3310	121000-3330			
121000-3340	121000-3360	121000-3370			

WITHOUT PLASTIC SHIELD, FOR PLASTIC SHIELD W115-41, RUBBER SEALS W115-37, W115-86, W115-96, SPRINGS W115-219

NIPPONDENSO



W155-02

NIPPONDENSO ALTERNATOR BRUSH HOLDER

HONDA	TOYOTA				
14129	14184				
021000-0810	021000-5410				

FOR BRUSHES USE W035-01

NIPPONDENSO



W155-05

NIPPONDENSO ALTERNATOR BRUSH HOLDER

CHRYSLER	DODGE	PLYMOUTH			
39-8201	BH-ND02				
13185	13220	14869			
121000-2430	121000-2660	121000-2680			

EXTERNAL REGULATOR STYLE. FOR BRUSHES USE W035-04, FOR RUBBER GROMMET USE W155-22, W115-22-1, SPRINGS W115-219

NIPPONDENSO



W155-09

NIPPONDENSO ALTERNATOR BRUSH HOLDER

GEO SUZUKI	HINO TOYOTA	MACK			
12018	12213	13316	14676		
100211-6600	100213-0130	100213-0272			
100213-0273	100213-0330	100213-0370			

FOR BRUSHES USE W035-07, SPRINGS USE W115-10

NIPPONDENSO



W155-04

NIPPONDENSO ALTERNATOR BRUSH HOLDER

ACURA CASE	BOBCAT CATERPILLAR	BOMBARDIER CHEVROLET			
BHRA001					
11587	11748	12080	12081	12179	12180
12181	12182	12184	12185	12186	12187
100211-1031	100211-1101	100211-1571			
100211-1640	100211-1650	100211-1662			
100211-1670	100211-1680	100211-2360			

COMPLETE WITH RUBBER GROMMET, FOR BRUSHES USE W035-04, FOR GROMMET USE W115-22, W115-22-1, ALTERNATE W155-04B

NIPPONDENSO



W155-08

NIPPONDENSO ALTERNATOR BRUSH HOLDER

CHRYSLER JEEP	DODGE MITSUBISHI MOTOR	EAGLE PLYMOUTH			
39-8202	BH-ND03	BHRA002			
11094	11116	11117	11242	13184	13185
13245	13256	13280	13301	13302	13304
121000-3000	121000-3100	121000-3200			
121000-3300	121000-3310	121000-3330			
121000-3340	121000-3360	121000-3370			

FOR BRUSHES USE W035-04, FOR PLASTIC SHIELD USE W115-41, FOR RUBBER SEAL USE W115-37, SPRINGS W115-219

NIPPONDENSO



W155-10

NIPPONDENSO ALTERNATOR BRUSH HOLDER

ACURA BOBCAT	AGCO CASE	ALLIS-CHALMERS CATERPILLAR			
39-8203	39-8203-3	BH-ND10			
11031	11049	11085	11086	11089	11092
11100	11101	11152	11164	11199	11531
100211-6020	100211-6031	100211-6040			
100211-6050	100211-6060	100211-6100			
100211-6110	100211-6130	100211-6150			

FOR BRUSHES USE W035-04, FOR PLASTIC SHIELD USED W115-41, FOR RUBBER SEAL USE W115-37, SPRINGS W115-219



NIPPONDENSO



W155-22
NIPPONDENSO ALTERNATOR BRUSH HOLDER

ACURA DODGE	CADILLAC HONDA	CHRYSLER JEEP
39-8207	BH-ND11	INB420-1

11003 11032 12660 13867	11039 11040 13868 13870	11048 11087 13871 13905
104210-3031 104210-3070 104210-3092	104210-3042 104210-3090 104210-3120	104210-3060 104210-3091 104210-3140

NOTICE MOUNT, BRUSHES W035-04, PLASTIC SHIELD W115-157, TOP RUBBER SEAL W115-156, BOTTOM SEAL W115-96, SPRINGS W115-219

NIPPONDENSO
POONG SUNG



POONG SUNG BRUSH HOLDER

HYUNDAI TOYOTA	KIA	SCION
39-8212	39-8213	BH-ND08

11190 11191 11203 11354	11192 11193 11505 11596	11194 11202 24027
02131-9132 02131-9262 02131-9320	02131-9153 02131-9271 02131-9321	02131-9261 02131-9280 02131-9330

12V, B-CIRCUIT, BRUSHES W035-04, SPRINGS W115-219

MOTOROLA
VALEO



494488
VALEO BRUSH HOLDER

AIFO MASSEY FERGUSO	IVECO MERCEDES HD	JOHN DEERE NEW HOLLAND
14327 14329	14388 14582	14610 14954

2541423 9AL2924K 9AR2690P	2940090 9AR2659K 9AR2760K	9AL2689K 9AR2660K 9AR2815K
---------------------------------	---------------------------------	----------------------------------

1/4" FIELD SPADE, 1/4" D- SPADE

12/24V, B-CIRCUIT, GROUNDED 1/4" SPADE, BRUSHES W036-00, SPRINGS W036-00S, CAN REPLACE MOST ALL

NIPPONDENSO



W155-24
NIPPONDENSO ALTERNATOR BRUSH HOLDER

ACURA CADILLAC	BMW CHEVROLET	BUICK CHRYSLER
39-8206	BH-ND12	

11000 11030 11036 11037	11032 11033 11038 11040	11034 11035 11044 11046
104210-1070 104210-1240 104210-1450	104210-1091 104210-1251 104210-1461	104210-1190 104210-1270 104210-1470

FOR BRUSHES USE W035-04, SPRINGS W115-219

SEV MARCHAL



W154-00
SEV ALTERNATOR BRUSH HOLDER

AUDI VOLVO	SAAB	VOLKSWAGEN
13105 14071	14224 14298	14408

71212002 71212602 9FE2KB2A08	71212102 9FE2KA2A11 9JG2KA2F56	71212402 9FE2KB2A07 9LG2KB2F51
------------------------------------	--------------------------------------	--------------------------------------

3 SPADE, FOR BRUSHES USE W036-00, ALSO SEE REPAIR PLUG W140-01, HARNESS W140-02.

VALEO



W152-00
PARIS RHONE ALTERNATOR BRUSH HOLDER

CITROEN PEGASO	DEUTZ-ALLIS PEUGEOT	KHD R.V.I.
12301 12702 14898 14954	12709 12710 22197 22405	14329 14582 22920 23602

71652602 A13N190 A13N22T	A13N11 A13N198 A13N255	A13N189 A13N21T A13N257
--------------------------------	------------------------------	-------------------------------

BRUSH HOLDER FOR REGULATOR W082-00, W082-04, FOR BRUSHES USE W032-00

NIPPONDENSO
POONG SUNG



W155-29
POONG SUNG BRUSH HOLDER

HYUNDAI TOYOTA	KIA	SCION
39-8212	39-8213	BH-ND08

11190 11191 11203 11354	11192 11193 11505 11596	11194 11202 24027
02131-9132 02131-9262 02131-9320	02131-9153 02131-9271 02131-9321	02131-9261 02131-9280 02131-9330

12V, B-CIRCUIT, BRUSHES W035-04, SPRINGS W115-219

SEV MARCHAL



W154-01
SEV ALTERNATOR BRUSH HOLDER

PEUGEOT VOLVO	PORSCHE	RENAULT
14226 14227	14228 14265	14280 14579

71210702 71223302 71226102	71214102 71223502 71228102	71220402 71223702 71228302
----------------------------------	----------------------------------	----------------------------------

SINGLE SPADE, FOR BRUSHES USE W036-00, SPRINGS W036-00S

VALEO



W152-02
PARIS RHONE ALTERNATOR BRUSH HOLDER

CITROEN	PEUGEOT	RENAULT
39-9404		

12049 14084 14566 14567	14308 14310 14568 14581	14329 14331 14582 14954
A11M4 A12M18 A12R11	A11M6 A12M8 A12R14	A12M10 A12R1 A12R19

FOR BRUSHES USE W032-02



VALEO



W152-03

VALEO ALTERNATOR BRUSH HOLDER

AKERMAK	BAUDOIN MARINE	BUKH
DAF	DEUTZ-ALLIS	KHD

12110	12301	12412	12415	12416	12417
12418	12420	12465	12598	13060	13068
A13N143M	A13N147M	A13N148M			
A13N165	A13N166M	A13N186M			
A13N1M	A13N236M	A13N28M			

14-28 VOLT, FOR W082-06, W082-08, W082-09, W082-10, W082-19N, W082-20N AND W082-21N.

MOTOROLA
VALEO

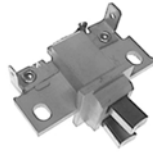

W156-01

MOTOROLA ALTERNATOR BRUSH HOLDER

BAUDOIN MARINE	BMW	BMW MARINE
CHRYSLER	DAF	FARYMANN

12154	12155	12292	12395	12397	12398
12399	12401	12402	12403	12405	12406
2518099		2940020		2940208	
2940753		2940754		2940926	
9AR2710P		9AR2712P		9AR2734P	

ISOLATED BRUSH FROM GROUND, FOR BRUSHES USE W036-00, FOR SPRING USE W036-00S

MANDO
VALEO



W155-28

MANDO ALTERNATOR BRUSH HOLDER

BOBCAT	KUBOTA	MELROE
MERCURY MARINE	OMC	PLEASURE CRAFT

12174	12175	
AR150AA	AR150BA	AR150CA
AR150DA		

12V, AR SERIES ALTERNATORS

MOTOROLA
VALEO



W156-00

MOTOROLA ALTERNATOR BRUSH HOLDER

ALLIS-CHALMERS	AUDI	AUSTIN
BMW	CARRIER	CASE

39-402

12103	12120	12121	12122	12143	12172
12173	12289	12290	12304	12306	12307
2518032		2518033		2518035	
2518073		2518074		2541128	
2541129		2541130		2541131	

USED ALSO ON VALEO ALTERNATORS, FOR BRUSHES USE W036-00, FOR SPRING USE W036-00S

Disclaimer

Wagner Alternators & Supplies, Inc. shall have neither liability nor responsibility to any person or entity with respect to loss and/or damages caused or alleged to be caused directly or indirectly by information contained in this catalog or any other Wagner Alternators & Supplies, Inc. publication, web site or sales representative.

The user acknowledges that they assume all risk and/or responsibility for any loss or damage arising from the uses to which the information provided by this catalog. Every effort has been made to make this information as complete and accurate as possible. However, there may be mistakes both typographical and in content. The information herein has been obtained through reliable sources and to the best of our knowledge is correct in content.

Any original equipment manufacturers or other manufacturers, or distributors, whose names, numbers, pictures, symbols, products and/or descriptions are, or may be, listed or shown are used for reference purposes only and there is no representation made or intended, nor implied that any item reference herein is the product of, or was manufactured and/or distributed, by, the referenced manufacturer or distributor. This catalog does not recommend any particular brand or product and no endorsements are implied. All company names and their products herein are covered by Copyright or Registered Trade Marks. Any use of them can lead to legal action.

Notice

All rights are reserved. Copies of information, product flyers and catalogs may be printed only for use in the normal course of business, and only for in-house use. No copies, reprints, reproductions, digital scanning, recording, distribution or publishing of any materials found on this site are permitted without the express written permission from Wagner Alternators & Supplies, Inc.

Prepared in U.S.A.

Copyright © 2017 by Wagner Alternators & Supplies, Inc.