

WAGNER

2017 WEB EDITION

DIODES & TRIOS



Helping You to Rebuild Tomorrow's World!



TERMS

CREDIT / PAYMENT TERMS

C.O.D. terms are cash or company check. Terms are C.O.D. until credit has been established by completing a credit application and being approved by WAGNER. An open account is Net 30 days from invoice date. Monthly statements will be mailed for your convenience.

Accounts exceeding 30 days are subject to 1.5% per month finance charge. Any account proceeding into 60 days past due status shall have all charge privileges suspended until account is paid in full, or at the discretion of management. Returned checks will be subject to a \$25.00 charge.

ORDER TERMS

Wagner Alternators & Supplies, Inc. reserves the right to accept any order or part thereof. **Orders under \$25 are subject to a \$5.00 special handling fee.**

SHIPPING TERMS

Merchandise is billed at the time of shipment. All prices are F.O.B., Chino, California, freight collect unless otherwise agreed in writing in advance by WAGNER. Orders are shipped via U.P.S., Federal Express, OnTrac or other common carriers unless otherwise specified at the time of order.

Shortages or incorrect merchandise must be reported within 10 days after receipt.

RETURNS

Any Return must be authorized in advance with a **RMA Number** and **must include** documentation of contents, original invoice number and reason for return. All boxes must have RMA number on outside of box. Returned merchandise may be subject to a 15% restocking charge and must be in the original box or package. **Unauthorized returns** are subject to 30% handling charge and/or return to customer.

LIMITED MANUFACTURER'S WARRANTY

Wagner's liability is limited to the repair, replacement or credit for the value of the product sold within one year of invoice date. If product is found to be defective, Wagner will not be responsible beyond the value of the defective piece, nor in any way be responsible for any damages or expenses caused by defective goods. Wagner is not responsible for any misuse of its products. Wagner will not be liable to replace any part which has been altered, defaced, modified, or treated in such a way the company finds unacceptable.

PRICING TERMS

Wagner Alternators & Supplies, Inc. will make every effort to keep its customers informed of any price changes. Wagner reserve the right to change prices without notice. From time to time, we may find it necessary to apply a surcharge occasionally to offset additional import costs. Any such charge will be noted on the invoice and we will do our best to inform the customer at the time the order is placed. All invoices reflect prices in effect at time of shipment.

Care is taken to ensure the accuracy of descriptions for each item, but Wagner assumes no responsibility for possible errors. **Permission to reproduce this catalog and/or contents is expressly denied.**

WAGNER NUMBERING SYSTEM

We have developed a simple yet efficient part numbering system that allows grouping of the electrical components by application (Alternator, Generator, or Starter), type of part (Rectifier, Brush, Solenoid, Etc.) and Manufacturer (Bosch, Lucas, Etc.).

EXAMPLE: W080-00H

The first letter signifies type of part:

W-Wagner Import Line	C- Chrysler
D-Delco	F-Ford
L-Leece Neville	M-Motorola
N-Nikko	P-Prestolite

The first two numerical digits represent the component classification:

ALTERNATOR

- 01-Alternator Covers
- 02-Bearings, Ball & Needle
- 03-Alternator Brushes
- 04-Diodes, Diode Trios
- 05-Pulleys
- 06-Rectifiers
- 07-Rotors
- 08-Int. Voltage Regulators
- 09-Ext. Voltage Regulators
- 10-Stators
- 11-Alternator Small Parts
- 12-Alternator CE Frames
- 13-Alternator DE Frame
- 14-Wire Harness/Repair Plugs
- 15-Brush Holders
- 16-Slip Rings
- 17-Ignition Modules
- 18-Grease/Paint/Supplies
- 19-Tools/Test Equipment

GENERATOR

- 26- Generator Armature
- 27-Generator Brushes
- 30-Gen CE Frame
- 31-Gen DE Frame

STARTER

- 40-Armatures
- 41-Starter Brushes
- 42-Bushings
- 45-Solenoids
- 46-Solenoid Caps
- 47-Starter Drives
- 48-Starter Small Parts
- 49-Starter CE Frame
- 50-Brush Holders
- 51-Housings
- 55-Testers

If a third digit shows, it represents the original Manufacturer in our Import line:

0 - Bosch	3 - Fiat, Magneti Marelli	6 - Motorola
1 - Lucas, Cav, Butec	4 - SEV	7 - Ducellier
2 - Paris Rhone, Valeo	5 - All Japanese	8 - Iskra

The final two numerical digits designate the specific identification number within each category. If the part number is not immediately followed by a letter, then it is an aftermarket replacement part.

Otherwise, one of the following may be used:

"N" Denotes Original OEM Part	"H" Denotes Hybrid
"S" Denotes Sold in Set	

Original Manufacturer names and numbers are used for reference purposes only.



BOSCH

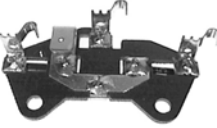

W040-00
BOSCH DIODE TRIO

ALFA ROMEO	ATLAS	AUDI
BMW	BOMAG	CASE
33-9100	DT-09	IB112
IB112-1		
12156 13009	13011 13014	13018 13025
13027 13028	13030 13031	13034 13038
0-120-400-600	0-120-400-604	0-120-400-605
0-120-400-606	0-120-400-608	0-120-400-609
0-120-400-611	0-120-400-614	0-120-400-620

1/4" SPADE

3 AMP, 100V DIODES, FOR REPLACEMENT DIODES USE W04X-01

BOSCH UNIVERSAL



W04X-39
BOSCH 1/2" AVL DIODE - NEGATIVE 50A 22V

ALFA ROMEO	AUDI	BMW
CADILLAC	CASE	FIAT
32-9102	8455	DD-1053
12161 12671	12672 13356	13357 13359
13376 13380	13381 13382	13417 13422
0-120-465-006	0-120-465-007	0-120-465-017
0-120-465-020	0-120-465-021	0-120-465-026
0-120-465-028	0-120-465-031	0-120-485-022

12.8mm(1/2") OD

50 AMP, 23-32 VOLT AVALANCHE, NEGATIVE, PRESSED IN FROM THE BACK TO THE BOSCH BASE RIM, SET WITH W04X-40, BOSCH AND VALEO

BOSCH UNIVERSAL



W04X-42
1/2" DIODE - POSITIVE 70A 200V FLUSH

FORD	LINCOLN	MERCURY
32-1060912	8270	
7795 8253	8315	
1-005-831-897	3W1U-10300-BB	F06-06HD
F8AU-10300-AB	F8AU-10300-AC	F8AU-10300-AD
WR2A-10300-AC	XF2U-10300-BC	

12.8mm(1/2") OD

70 AMP, 200 VOLT, POSITIVE, PRESSED IN FLUSH FROM THE BACK, FOR NEGATIVE USE W04X-41

BOSCH UNIVERSAL



W04X-28
BOSCH 1/2" DIODE - NEGATIVE 35A 200V

AGCO	AIFO	AKERMAK
ALFA ROMEO	ATLAS	AUDI
32-9100	8235	DD-1022
12048 12049	12102 12110	12134 12156
12161 12297	12301 12302	12411 12412
0-120-400-600	0-120-400-604	0-120-400-605
0-120-400-606	0-120-400-608	0-120-400-609
0-120-400-611	0-120-400-614	0-120-400-620

12.8mm(1/2") OD

35 AMP, 200 VOLT, NEGATIVE, PRESSED IN FROM THE BACK TO THE BOSCH BASE RIM, FOR POSITIVE USE W04X-29

BOSCH UNIVERSAL



W04X-40
BOSCH 1/2" AVL DIODE - POSITIVE 50A 22V

ALFA ROMEO	AUDI	BMW
CADILLAC	CASE	FIAT
32-9103	8454	DD-1054
12161 12671	12672 13356	13357 13359
13376 13380	13381 13382	13417 13422
0-120-465-006	0-120-465-007	0-120-465-017
0-120-465-020	0-120-465-021	0-120-465-026
0-120-465-028	0-120-465-031	0-120-485-022

12.8mm(1/2") OD

50 AMP, 23-32 VOLT AVALANCHE, POSITIVE, PRESSED IN FROM THE BACK TO THE BOSCH BASE RIM, SET WITH W04X-39

BOSCH UNIVERSAL



W04X-43
1/2" AVL DIODE - NEGATIVE 50A 39V FLUSH

CUMMINS	DAF	EL DETALLE
IVECO	JOHN DEERE	KHD
8467	DD-1091	
12387 12389	12493 12591	12594 12599
12724 12793	12811 12812	23833 23868
0-124-555-001	0-124-555-002	0-124-555-004
0-124-555-005	0-124-555-006	0-124-555-007
0-124-555-008	0-124-555-009	0-124-555-011

12.8mm(1/2") OD

50 AMP, 39 VOLT AVALANCHE, NEGATIVE, USED ON 24 VOLT SYSTEMS, PRESSED IN FLUSH FROM THE BACK, POSITIVE W04X-44

BOSCH UNIVERSAL



W04X-29
BOSCH 1/2" DIODE - POSITIVE 35A 200V

AGCO	AIFO	AKERMAK
ALFA ROMEO	ATLAS	AUDI
32-9101	8234	8236
8710	DD-1023	
12048 12049	12102 12110	12134 12156
12161 12301	12302 12411	12412 12415
0-120-400-600	0-120-400-604	0-120-400-605
0-120-400-606	0-120-400-608	0-120-400-609
0-120-400-611	0-120-400-614	0-120-400-620

12.8mm(1/2") OD

35 AMP, 200 VOLT, POSITIVE, PRESSED IN FROM THE BACK TO THE BOSCH BASE RIM, FOR NEGATIVE USE W04X-28

BOSCH UNIVERSAL



W04X-41
1/2" DIODE - NEGATIVE 70A 200V FLUSH

FORD	LINCOLN	MERCURY
32-1060913	8271	
7795 8253	8315	
3W1U-10300-BB	F06-06HD	F8AU-10300-AB
F8AU-10300-AC	F8AU-10300-AD	WR2A-10300-AC
XF2U-10300-BC		

12.8mm(1/2") OD

70 AMP, 200 VOLT, NEGATIVE, PRESSED IN FLUSH FROM THE BACK, FOR POSITIVE USE W04X-42

BOSCH UNIVERSAL



W04X-44
1/2" AVL DIODE - POSITIVE 50A-39V FLUSH

CUMMINS	DAF	EL DETALLE
IVECO	JOHN DEERE	KHD
32-1060102	8466	DD-1092
12387 12389	12493 12591	12594 12599
12724 12793	12811 12812	23515 23833
0-124-555-001	0-124-555-002	0-124-555-004
0-124-555-005	0-124-555-006	0-124-555-007
0-124-555-008	0-124-555-009	0-124-555-011

12.8mm(1/2") OD

50 AMP, 39 VOLT AVALANCHE, POSITIVE, USED ON 24 VOLT SYSTEMS, PRESSED IN FLUSH FROM THE BACK, NEGATIVE W04X-43



BOSCH UNIVERSAL



W04X-45
1/2" DIODE - NEGATIVE 50A 400V FLUSH

BMW FORD H.D.	DODGE LINCOLN	FORD MAZDA
32-201 8255	32-203-1 DD-1036	8253
11235 11239 13843 13920	11314 13235 13987 14782	13363 13604 14791 14812
0-120-468-009 0-120-468-012 0-120-468-057	0-120-468-010 0-120-468-015 0-120-468-058	0-120-468-011 0-120-468-016 0-120-468-059

12.8mm(1/2") OD

50 AMP, 400 VOLT, NEGATIVE, PRESSED IN FLUSH FROM THE BACK, FOR POSITIVE USE W04X-46

BOSCH UNIVERSAL



W04X-52
1/2" AVL DIODE - POSITIVE 50A-22V FLUSH

AUDI BOBCAT	BLUE BIRD BUICK	BMW CADILLAC
DD-1064		
11011 11014 11019 11020	11015 11016 11021 11022	11017 11018 11023 11041
0-121-615-002 0-121-615-008 0-121-615-012	0-121-615-003 0-121-615-010 0-121-615-014	0-121-615-005 0-121-615-011 0-121-615-016

12.8mm(1/2") OD

50 AMP, 22 VOLT AVALANCHE, POSITIVE, PRESSED IN FLUSH FROM THE BACK, FOR NEGATIVE USE W04X-51

BUTEC



W041-01
BUTEC DIODE TRIO

JAGUAR

14038

A7/1A/00193 A7/1A/03598 A7/1B/13602

M5 POST

EXTERNAL TRIO

BOSCH UNIVERSAL



W04X-46
1/2" DIODE - POSITIVE 50A 400V FLUSH

BMW FORD H.D.	DODGE LINCOLN	FORD MAZDA
32-200 DD-1037	8252	8254
11235 11239 13843 13920	11314 13235 13987 14782	13363 13604 14791 14812
0-120-468-009 0-120-468-012 0-120-468-057	0-120-468-010 0-120-468-015 0-120-468-058	0-120-468-011 0-120-468-016 0-120-468-059

12.8mm(1/2") OD

50 AMP, 400 VOLT, POSITIVE, PRESSED IN FLUSH FROM THE BACK, FOR NEGATIVE USE W04X-45

BOSCH UNIVERSAL



W04X-53
1/2" AVL DIODE - NEGATIVE 70A-22V FLUSH

AGCO CASE	AUDI CATERPILLAR	BMW CHAMPION
32-1080201	DD-1089	
11067 11068 11081 11083	11074 11078 11216 11217	11079 11080 11257 11262
0-122-0AA-090 0-122-0AA-0R0 0-122-0AA-1A0	0-122-0AA-0B0 0-122-0AA-140 0-122-0AA-1D0	0-122-0AA-0D0 0-122-0AA-160 0-122-0AA-1H0

12.8mm(1/2") OD

70 AMP, 22 VOLT AVALANCHE, NEGATIVE, PRESSED IN FLUSH FROM THE BACK, FOR POSITIVE USE W04X-54

DELCO UNIVERSAL



D04-02
DELCO DIODE TRIO-BLACK 10SI

ALLIS-CHALMERS BOBCAT	AMC BUICK	AUSTIN WESTERN CADILLAC
33-100 D528	33-100-4 DT-01	33-110
7127-12 7127-3 7134-12 7134-3	7127-6 7127-9 7134-6 7134-6R	7128 7133 7134-9 7134-9R
10479825 10479858 10479865	10479826 10479860 10479867	10479833 10479862 1100114

STANDARD

3 AMP DIODES, BLACK, 10SI, 12SI, 15SI, 17SI, ALTERNATE D04-03

BOSCH UNIVERSAL



W04X-51
1/2" AVL DIODE - NEGATIVE 50A-22V FLUSH

AUDI BOBCAT	BLUE BIRD BUICK	BMW CADILLAC
DD-1063		
11011 11014 11019 11020	11015 11016 11021 11022	11017 11018 11023 11041
0-121-615-002 0-121-615-008 0-121-615-012	0-121-615-003 0-121-615-010 0-121-615-014	0-121-615-005 0-121-615-011 0-121-615-016

12.8mm(1/2") OD

50 AMP, 22 VOLT AVALANCHE, NEGATIVE, PRESSED IN FLUSH FROM THE BACK, FOR POSITIVE USE W04X-52

BOSCH UNIVERSAL



W04X-54
1/2" AVL DIODE - POSITIVE 70A-22V FLUSH

AGCO CASE	AUDI CATERPILLAR	BMW CHAMPION
32-1080200	DD-1090	
11067 11068 11081 11083	11074 11078 11216 11217	11079 11080 11257 11262
0-122-0AA-090 0-122-0AA-0R0 0-122-0AA-1A0	0-122-0AA-0B0 0-122-0AA-140 0-122-0AA-1D0	0-122-0AA-0D0 0-122-0AA-160 0-122-0AA-1H0

12.8mm(1/2") OD

70 AMP, 22 VOLT AVALANCHE, POSITIVE, PRESSED IN FLUSH FROM THE BACK, FOR NEGATIVE USE W04X-53

DELCO UNIVERSAL



D04-03
DELCO DIODE TRIO-ORANGE 10SI

ALLIS-CHALMERS BOBCAT	AMC BUICK	AUSTIN WESTERN CADILLAC
33-100-1	D527	DT-01R
7127-12 7127-3 7134-6R 7134-9	7127-6 7127-9 7134-R 7137-12	7134-12 7134-6 7137-3 7137-6
1100109 1100113 1100120	1100110 1100115 1100121	1100111 1100119 1100122

STANDARD

3 AMP DIODES, ORANGE, 10SI, 12SI, 15SI, 17SI, ALTERNATE D04-02



DELCO UNIVERSAL



D04-04
DELCO DIODE TRIO-40SI

CHEVROLET	CUMMINS	INTERNATIONAL
33-105	D572	
7239 7246	7250 7251	
1117141	1117142	1117143
1117144	1117145	1117146
1117147	1117148	1117149

3 AMP DIODES, 40SI

DELCO UNIVERSAL



D04-07
DELCO DIODE TRIO 27SI

ALLIS-CHALMERS BUICK	AUSTIN WESTERN CADILLAC	AUTOCAR CATERPILLAR
33-102 DT-06	33-102-1	D1001
7135 7136 7160 7161	7138 7139 7197 7847	7157M 7850 7899
1100072	1100073	1100075
1100076	1100077	1100078
1100081	1100082	1100083

3 AMP DIODES, 27SI

DELCO UNIVERSAL



D04-10
1/4-28 DIODE POSITIVE 70A-200V

BLUE BIRD PETERBILT	CHEVROLET	INTERNATIONAL
1120	32-769	DD-1120P

1/4-28 THREAD

70 AMP, 200 VOLT, POSITIVE, COMMONLY USED IN LEECE NEVILLE AND SOME BATTERY CHARGERS

DELCO UNIVERSAL



D04-05
DELCO DIODE TRIO 30SI

CASE CHEVROLET	CATERPILLAR CUMMINS	CHAMPION FORD
33-104	D797	DT-11
7256 7262 7650 7676	7263 7265 7940 7947	7267 7276 7965 7975
1117067	1117068	1117481
1117482	1117483	1117484
1117485	1117648	1117732

3 AMP DIODES, 30SI

DELCO UNIVERSAL

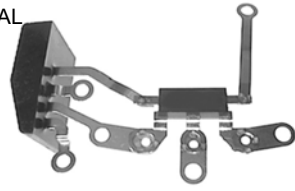

D04-08
DELCO DIODE TRIO 22SI

CHEVROLET FORD H.D.	CUMMINS FREIGHTLINER	FORD INTERNATIONAL
33-108	DT-18	DT22
8070 8071 8076 8078	8072 8073 8079 8360	8074 8075 8361 8366
19010190	19010191	19010192
19020300	19020302	19020303
19020304	19020305	19020306

3 AMP DIODES, 22SI, WITH AUTO START

DELCO UNIVERSAL



D04-11
DELCO DIODE NEGATIVE-50DN

BLUE BIRD PETERBILT	CHEVROLET	INTERNATIONAL
32-104 DD-867D	837M	867D
7257 7258 7655 8352	7259 7260 8353 8354	7653 7654 8356 8357
1117661	1117665	1117667
1117670	1117672	1117673
1117675	1117677	1117678

3/8"-24 STUD MOUNT

150 AMP, 200 VOLT, NEGATIVE, 50DN, FOR POSITIVE SEE D04-12

DELCO UNIVERSAL



D04-06
DELCO DIODE TRIO 17SI, 21SI

AGCO CADILLAC	BUHLER CATERPILLAR	BUICK CHAMPION
33-101	D985	DT-10
7287-12 7287-3 7564 7565	7287-6 7287-9 7641 7642	7288-12 7288-9 7644 7659
1101215	1101252	1101258
1101290	1105585	1105613
1105656	1105658	1105680

61mm BOLT PATTERN

3 AMP DIODES, 17SI, 21SI

DELCO UNIVERSAL



D04-09
1/4"-28 DIODE NEGATIVE 70A-200V

BLUE BIRD PETERBILT	CHEVROLET	INTERNATIONAL
1120R	32-768	DD-1120R

1/4-28 THREAD

70 AMP, 200 VOLT, NEGATIVE, COMMONLY USED IN LEECE NEVILLE AND SOME BATTERY CHARGERS

DELCO UNIVERSAL



D04-12
DELCO DIODE POSITIVE-50DN

BLUE BIRD PETERBILT	CHEVROLET	INTERNATIONAL
32-105 DD-866D	866D	866M
7257 7258 7655 8352	7259 7260 8353 8354	7653 7654 8356 8357
1117661	1117663	1117664
1117665	1117667	1117668
1117669	1117670	1117672

3/8"-24 STUD MOUNT

150 AMP, 200 VOLT, POSITIVE, 50DN, FOR NEGATIVE SEE D04-11



DELCO
UNIVERSAL



D04-13
DELCO DIODE TRIO 33SI, 34SI, 35SI

FORD INTERNATIONAL	FORD H.D. KENWORTH	FREIGHTLINER MACK
33-109	DT-16	DT182

8080	8081	8082	8083	8085	8090
8091	8092	8093	8094	8095	8096
19011150	19011151	19011152			
19011153	19011154	19011155			
19011156	19011157	19011158			

62mm BOLT PATTERN

3 AMP DIODES, 33SI, 34SI, 35SI, 36SI SERIES

DELCO
UNIVERSAL



W04X-49
1/2" DIODE - NEGATIVE 35A 200V 10DN

AUTOCAR CUMMINS	CATERPILLAR DETROIT	CHEVROLET FORD
32-102	8981	DD-1003

7237	7241	7245	7252	7254	7255
7649	7657	7674	7675	8060	8061
1117069		1117155		1117167	
1117225		1117226		1117227	
1117228		1117229		1117231	

1/2" OD

35 AMP, 200 VOLT, NEGATIVE, FOR POSITIVE USE
W04X-50, SEE W04X-33 25A 200V

DUCELLIER
MARELLI



W047-00
DUCELLIER DIODE TRIO

FIAT	FIAT-ALLIS	IVECO
33-9403	DT-07	ID599

12026	12580	14294	14954
-------	-------	-------	-------

515010A	516021A	63305206
63305431	63306000	63306300
7564A	7565C	7567C

1.5 AMP, 100 VOLT DIODES, WITHOUT LEAD, ALTERNATE W043-01

DELCO
UNIVERSAL



W04X-33
1/2" DELCO DIODE - NEGATIVE 25A 200V

ALLIS-CHALMERS BAKER	AMC BUICK	AUSTIN WESTERN CADILLAC
32-100 DD-1001	32-107	8961

12280	13075	7106	7107	7109	7111
7113	7116	7117	7122	7141	7143
1100059		1100062		1100063	
1100064		1100065		1100066	
1100067		1100068		1100071	

1/2" OD

25 AMP, 200 VOLT, NEGATIVE, FOR POSITIVE USE
W04X-34, ALTERNATE W04X-49

DELCO
UNIVERSAL



W04X-50
1/2" DIODE - POSITIVE 35A 200V 10DN

AUTOCAR CUMMINS	CATERPILLAR DETROIT	CHEVROLET FORD
32-103	8980	DD-1004

7237	7241	7245	7252	7254	7255
7649	7657	7674	7675	8060	8061
1117069		1117155		1117167	
1117225		1117226		1117227	
1117228		1117229		1117231	

1/2" OD

35 AMP, 200 VOLT, POSITIVE, FOR NEGATIVE USE
W04X-49, SEE W04X-34 25A 200V

HITACHI
UNIVERSAL



W045-02
HITACHI DIODE - NEGATIVE 30A 200V

HONDA ISUZU	INFINITI JOHN DEERE	INGERSOLL RAND KIA
32-8102 8671	8631 DD-1065	8631-3

12042	12112	12761	13273	13275	13285
13287	13334	13474	13533	13564	13636
L170G-6320		LR1110-707F		LR140-721B	
LR140-721C		LR140-723		LR150-711	
LR150-714		LR150-715		LR160-723	

11.75mm OD

30 AMP, 200 VOLT, NEGATIVE, FITS RECTIFIER W065-64, W065-68, W065-82, W065-172.

DELCO
UNIVERSAL



W04X-34
1/2" DELCO DIODE - POSITIVE 25A 200V

ALLIS-CHALMERS BAKER	AMC BUICK	AUSTIN WESTERN CADILLAC
32-101 DD-1002	32-108	8960

12280	13075	7106	7107	7109	7111
7113	7116	7117	7122	7141	7143
1100059		1100062		1100063	
1100064		1100065		1100066	
1100067		1100068		1100071	

1/2" OD

25 AMP, 200 VOLT, POSITIVE, FOR NEGATIVE USE
W04X-33

DUCELLIER
MARELLI
UNIVERSAL



W043-01
MARELLI DIODE TRIO

FIAT	FIAT-ALLIS	IVECO
33-9402 IX700-1	DT-08	IX699

12026	12580	14293	14294	14954
-------	-------	-------	-------	-------

516021A	63305206	63305400
63305431	63306000	63306300
7564A	7565C	7567C

1/4" PUSH ON

1.5 AMP, 100 VOLT DIODES, WITH LEAD, MARELLI AND DUCELLIER, ALTERNATE W047-00

HITACHI
UNIVERSAL



W045-03
HITACHI DIODE - POSITIVE 30A 200V

HONDA ISUZU	INFINITI JOHN DEERE	INGERSOLL RAND KIA
32-8103 DD-1066	8630	8670

12042	12112	12761	13273	13275	13285
13287	13334	13474	13533	13564	13636
L170G-6320		LR1110-707F		LR140-721B	
LR140-721C		LR140-723		LR150-711	
LR150-714		LR150-715		LR160-723	

11.75mm OD

30 AMP, 200 VOLT, POSITIVE, FITS RECTIFIER W065-64, W065-68, W065-82, W065-172.



HITACHI UNIVERSAL



W045-04
HITACHI AVL DIODE - NEGATIVE 50A 23V

AUDI ISUZU	HONDA MAZDA	INFINITI NISSAN
32-8108	8661	DD-1069
11009 11027 11165 12240	11119 11120 12536 13215	11121 11163 13612 13639
L1100G-23201 L190G-33201 LR1100-705C 11.75mm OD	L1100G-4320 LR1100-704 LR1100-709B	L1100G-7320 LR1100-704B LR1100-711

50 AMP, 23 VOLT AVALANCHE, NEGATIVE, FOR POSITIVE USE W045-05

HITACHI UNIVERSAL



W045-07
HITACHI DIODE - POSITIVE 35A 200V

CHEVROLET ISUZU	HONDA ISUZU HD	INFINITI NISSAN
32-8105 DD-1060	8640	8640-3
12335 12336 13531 13642	13261 13329 13713 13825	13474 13477
LR1100-702 LR1110-702 LR180-510 11.75mm OD	LR1110-701 LR160-724 LR180-725	LR1110-701B LR180-509C LR180-725B

35 AMP, 200 VOLT, POSITIVE, FITS RECTIFIER W065-82, W065-94, W065-95, W065-171, W065-185, W065-192, RELATED TO NEGATIVE W045-06

LEECE-NEVILLE



L04-02
LEECE NEVILLE DIODE NEGATIVE

DODGE KENWORTH	FORD H.D.	INTERNATIONAL
32-500	DD-1136	LR77325
7602 7608 7677 7688	7611 7631 7689 7700	7637 7639 7709 8340
2300J 2600J 7600A 1/2" OD	2360J 4425J 7600JA	2500J 4625JA 7601A

35 AMP, 200 VOLT, NEGATIVE, SET WITH POSITIVE L04-07

HITACHI UNIVERSAL



W045-05
HITACHI AVL DIODE - POSITIVE 50A 23V

AUDI ISUZU	HONDA MAZDA	INFINITI NISSAN
32-8109	8660	DD-1070
11009 11027 11165 12240	11119 11120 12536 13215	11121 11163 13612 13639
L1100G-23201 L190G-33201 LR1100-705C 11.75mm OD	L1100G-4320 LR1100-704 LR1100-709B	L1100G-7320 LR1100-704B LR1100-711

50 AMP, 23 VOLT AVALANCHE, POSITIVE, FOR NEGATIVE USE W045-04

LEECE-NEVILLE



L04-00
LEECE NEVILLE DIODE NEGATIVE

FORD PETERBILT	FREIGHTLINER VOLVO HD	INTERNATIONAL WESTERN STAR
32-502	LR71198	
7612 7632 7772 8337	7640 7661 8342	7763 7767
2700J 4750J 7704JA 1/2" OD	4725A 7700JA 7705JA	4725JA 7702JA 7706A

70 AMP, 200 VOLT, NEGATIVE, USED ON 130-165 AMP UNITS, FOR POSITIVE USE L04-01, ALTERNATE W04X-36

LEECE-NEVILLE



L04-03
LEECE NEVILLE DIODE TRIO

FORD	FORD H.D.
33-502	DT-15 L79026
7631 7632 7689 7700	7639 7640 7767 7772
7600JA 7604JA 7607JA	7601JA 7605JA 7700JA
	7602JA 7606JA 7702JA

1 AMP DIODES, 4400-4700J, 7000-7700J SERIES

HITACHI UNIVERSAL



W045-06
HITACHI DIODE - NEGATIVE 35A 200V

CHEVROLET ISUZU	HONDA ISUZU HD	INFINITI NISSAN
32-8104 DD-1059	8641	8641-3
12335 12336 13531 13642	13261 13329 13713 13825	13474 13477
LR1100-702 LR1110-702 LR180-509C 11.75mm OD	LR1110-701 LR1110-703B LR180-510	LR1110-701B LR160-724 LR180-725

35 AMP, 200 VOLT, NEGATIVE, FITS RECTIFIER W065-82, W065-94, W065-95, W065-171, W065-185, W065-192, RELATED TO POSITIVE W045-07

LEECE-NEVILLE



L04-01
LEECE NEVILLE DIODE POSITIVE

FORD PETERBILT	FREIGHTLINER VOLVO HD	INTERNATIONAL WESTERN STAR
32-503	LR71199	
7612 7632 7772 8337	7640 7661 8342	7763 7767
2700J 4750J 7704JA 1/2" OD	4725A 7700JA 7705JA	4725JA 7702JA 7706A

70 AMP, 200 VOLT, POSITIVE, USED ON 130-165 AMP UNITS, FOR POSITIVE USE L04-00, ALTERNATE W04X-35

LEECE-NEVILLE



L04-04
LEECE NEVILLE DIODE TRIO

DODGE FREIGHTLINER	DRESSER IH (INTERNATIONAL)	FORD H.D. INTERNATIONAL
33-500 L79027-1	DT-13	L79027
7302 7604 8503 8504	7606 7608	7610 7613
2300JC 2360JC 2513JC	2302JB 2500JC 2526JC	2304J 2511J 2800JC

SAME APPLICATIONS AS L04-05

1 AMP DIODES, 2300-2800JB, FOR HEAVY DUTY USE L04-05



LEECE-NEVILLE

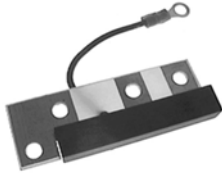

L04-05
LEECE NEVILLE DIODE TRIO

DODGE	DRESSER	FORD H.D.	
FREIGHTLINER	IH (INTERNATIONAL	INTERNATIONAL	
L79027HD	L79027HD-1		
7602 7603	7604 7605	7606 7608	
7610 7611	7612 7613	7614 8504	
2300J	2301J	2302J	
2302JB	2303J	2304J	
2360J	2500J	2509J	

3 AMP DIODES, HEAVY DUTY, 2300-2800JB

LUCAS



W041-00
LUCAS SURGE DIODE

AUSTIN	FORD	FORD AG	
LOTUS	MASSEY FERGUSO	MERCURY	
TUZZ-106			
12038 12039	12152 14008	14013 14014	
14019 14022	14025 14029	14030 14037	
23544A/F	23548A/D	23562A/D	
23563A	23565A/B	23566A	
23572A	23581A/E	23582A	

25 AMP, 27 VOLT ZIENER DIODE

MANDO
MITSUBISHI
UNIVERSAL



W04X-24
MITSUBISHI SQUARE DIODE-POSITIVE 30A 200V

ACURA	BOBCAT	CASE	
CATERPILLAR	CHEVROLET	CHRYSLER	
32-8300	8330	DD-5028	
11029 11055	11057 11058	11095 11118	
11176 11317	11558 12077	12136 12138	
0206-102-0110	0206-102-0211	2656068	
A002TG1891	A0T25471	A1T01991	
A1T02291	A1T02592	A1T02674	

LOW PROFILE

30 AMP, 200 VOLT, POSITIVE, FOR NEGATIVE USE W04X-25

LEECE-NEVILLE

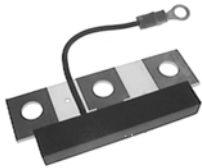

L04-06
LEECE NEVILLE DIODE TRIO

DODGE	FORD H.D.	FREIGHTLINER	
IH (INTERNATIONAL	INTERNATIONAL	KENWORTH	
33-501	DT-14	L79480	
7616 7617	7619 8340	8341 8342	
8343 8344	3625J	3725J	
3425J	4426J	4625JA	
4425J	4632J	4725JA	

1 AMP DIODES, 3425, 4725JA SERIES UNITS

LUCAS
UNIVERSAL



W04X-22
LUCAS DIODE - POSITIVE 35A 200V

CASE	FORD	FORD AG	
IH (INTERNATIONAL	J.C. BAMFORD	JAGUAR	
32-9201 9230	9224 DD-1039	9226	
12038 12040	12041 12045	12046 12047	
12072 12073	12074 12089	12090 12091	
23970A/B	23971A	23996A	
24011A	24037A/B	24049A	
24055A/B	24056A/B	24061A/B	

10mm OD, 1" STEM

35 AMP, 200 VOLT, POSITIVE, FOR NEGATIVE USE W04X-23, REPAIRS RECTIFIER W061-06

MANDO
MITSUBISHI
UNIVERSAL



W04X-25
MITSUBISHI SQUARE DIODE-NEGATIVE 30A 200V

ACURA	BOBCAT	CASE	
CATERPILLAR	CHEVROLET	CHRYSLER	
32-8301	8331	DD-5027	
11029 11055	11057 11058	11095 11118	
11176 11317	11558 12077	12136 12138	
0206-102-0110	0206-102-0211	2656068	
A002TG1891	A0T25471	A1T01991	
A1T02291	A1T02592	A1T02674	

LOW PROFILE

30 AMP, 200 VOLT, NEGATIVE, FOR POSITIVE USE W04X-24

LEECE-NEVILLE



L04-07
LEECE NEVILLE DIODE POSITIVE

DODGE	FORD H.D.	INTERNATIONAL	
KENWORTH			
32-501	DD-1135	LR79084	
7602 7608	7611 7631	7637 7639	
7677 7688	7689 7700	7709 8340	
2300J	2360J	2500J	
2600J	4425J	4625JA	
7600A	7600JA	7601A	

1/2" OD

35 AMP, 200 VOLT, POSITIVE, SET WITH NEGATIVE L04-02

LUCAS
UNIVERSAL



W04X-23
LUCAS DIODE - NEGATIVE 35A 200V

CASE	FORD	FORD AG	
IH (INTERNATIONAL	J.C. BAMFORD	JAGUAR	
32-9200 DD-1038	9225	9231	
12038 12040	12041 12045	12046 12047	
12072 12073	12074 12089	12090 12091	
23970A/B	23971A	23996A	
24011A	24037A/B	24049A	
24055A/B	24056A/B	24061A/B	

10mm OD, 1" STEM

35 AMP, 200 VOLT, NEGATIVE, FOR POSITIVE USE W04X-22, REPAIRS RECTIFIER W061-06

MARELLI
UNIVERSAL



W043-00
FIAT DIODE TRIO

FIAT	MASSEY FERGUSO		
12280 13131	13132	13137	
63303100	63303311	63303320	
63303321	63303360	63303380	
63303391	63303600	63303610	

1/4" SPADE

1.5 AMP, 100 VOLT DIODES, W04X-13



DUCELLIER
MARELLI
UNIVERSAL



W043-01
MARELLI DIODE TRIO

FIAT	FIAT-ALLIS	IVECO
33-9402 IX700-1	DT-08	IX699
12026 12580	14293 14294	14954
516021A 63305431 7564A	63305206 63306000 7565C	63305400 63306300 7567C

1/4" PUSH ON

1.5 AMP, 100 VOLT DIODES, WITH LEAD, MARELLI AND DUCELLIER, ALTERNATE W047-00

MANDO
MITSUBISHI
UNIVERSAL



W04X-24
MITSUBISHI SQUARE DIODE-POSITIVE 30A 200V

ACURA	BOBCAT	CASE
CATERPILLAR	CHEVROLET	CHRYSLER
32-8300	8330	DD-5028
11029 11055 11176 11317	11057 11058 11558 12077	11095 11118 12136 12138
0206-102-0110 A002TG1891 A1T02291	0206-102-0211 A0T25471 A1T02592	2656068 A1T01991 A1T02674

LOW PROFILE

30 AMP, 200 VOLT, POSITIVE, FOR NEGATIVE USE W04X-25

MOTOROLA
PRESTOLITE



P04-00
PRESTOLITE DIODE TRIO

CARRIER	CRUSADER	MERCURY MARINE
OMC	ONAN	THERMO KING
33-402	M206	
7344 7465 7481 7484	7477 7478 7496 7498	7479 7480 7563 7566
8EA2001F 8EA2003FB 8EA2006K	8EA2002FA 8EA2004F 8EA2007K	8EA2003FA 8EA2005K 8EA2008K

(2) 10-24, 1/4-20 POSTS

3 AMP DIODES, STANDARD THREADS, ALTERNATE P04-01

MARELLI
UNIVERSAL



W043-02
MAGNET-MARELLI DIODE TRIO

LANDROVER		
IX633		
13726		
63321200 63321234	63321204 63321240	63321233

1.5 AMP, 100 VOLT, USED ON W063-05, W063-06 RECTIFIER

MANDO
MITSUBISHI
UNIVERSAL



W04X-25
MITSUBISHI SQUARE DIODE-NEGATIVE 30A 200V

ACURA	BOBCAT	CASE
CATERPILLAR	CHEVROLET	CHRYSLER
32-8301	8331	DD-5027
11029 11055 11176 11317	11057 11058 11558 12077	11095 11118 12136 12138
0206-102-0110 A002TG1891 A1T02291	0206-102-0211 A0T25471 A1T02592	2656068 A1T01991 A1T02674

LOW PROFILE

30 AMP, 200 VOLT, NEGATIVE, FOR POSITIVE USE W04X-24

MOTOROLA



W046-01
MOTOROLA DIODE TRIO

AUDI	VOLKSWAGEN	
33-401	M129 M129-1	
13105 13106 14401 14402	13113 14071 14406 14408	14081 14297 14831 7454
9BE2KA2A21 9BE2NE2A41 9FB2KB2A04	9BE2KD2A40 9DA2LA2B07 9FB2KB2A06	9BE2NB2A45 9DB2LG2B59 9FB2LD2A05

3/4" 10/24 THREAD, 3" FLEX LEADS

3 AMP, 100 VOLT, FOR SINGLE DIODE USE W04X-01

DUCELLIER
MARELLI



W047-00
DUCELLIER DIODE TRIO

FIAT	FIAT-ALLIS	IVECO
33-9403	DT-07	ID599
12026 12580	14294 14954	
515010A 63305431 7564A	516021A 63306000 7565C	63305206 63306300 7567C

1.5 AMP, 100 VOLT DIODES, WITHOUT LEAD, ALTERNATE W043-01

MOTOROLA



M04-00
MOTOROLA DIODE TRIO

AMC	CARRIER	CASE
CLARK	CRUSADER	CUMMINS
33-400	M130	M130-1
7374 7377 7429 7434	7378 7394 7435 7437	7417 7427 7439 7443
8AL2011F 8AL2014F 8AL2017F	8AL2012F 8AL2015K 8AL2021L	8AL2013F 8AL2016K 8AL2025F

1 1/2" 10/24 THREAD, FLEX LEADS

3 AMP, 200 VOLT, 8AL SERIES

MOTOROLA
UNIVERSAL



W046-02
UNIVERSAL DIODE TRIO

T200

1.5 AMP, 100 VOLT UNIVERSAL DIODE TRIO



MOTOROLA
PRESTOLITE



P04-00
PRESTOLITE DIODE TRIO

CARRIER	CRUSADER	MERCURY MARINE
OMC	ONAN	THERMO KING
33-402	M206	
7344 7465	7477 7478	7479 7480
7481 7484	7496 7498	7563 7566
8EA2001F	8EA2002FA	8EA2003FA
8EA2003FB	8EA2004F	8EA2005K
8EA2006K	8EA2007K	8EA2008K

(2) 10-24, 1/4-20 POSTS

3 AMP DIODES, STANDARD THREADS, ALTERNATE P04-01

DELCO
UNIVERSAL



D04-02
DELCO DIODE TRIO-BLACK 10SI

ALLIS-CHALMERS	AMC	AUSTIN WESTERN
BOBCAT	BUICK	CADILLAC
33-100	33-100-4	33-110
D528	DT-01	
7127-12 7127-3	7127-6 7127-9	7128 7133
7134-12 7134-3	7134-6 7134-6R	7134-9 7134-9R
10479825	10479826	10479833
10479858	10479860	10479862
10479865	10479867	1100114

STANDARD

3 AMP DIODES, BLACK, 10SI, 12SI, 15SI, 17SI, ALTERNATE D04-03

DELCO
UNIVERSAL



D04-05
DELCO DIODE TRIO 30SI

CASE	CATERPILLAR	CHAMPION
CHEVROLET	CUMMINS	FORD
33-104	D797	DT-11
7256 7262	7263 7265	7267 7276
7650 7676	7940 7947	7965 7975
1117067	1117068	1117481
1117482	1117483	1117484
1117485	1117648	1117732

3 AMP DIODES, 30SI

SEV MARCHAL



W044-00
SEV BUTTERFLY TRIO

PEUGEOT	PORSCHE	SAAB
VOLVO		
33-9401		
14224 14227	14228 14298	14572 14579
71210702	71210802	71210902
71212402	71212602	71236002
71271202	71271302	

1.5 AMP, 100 VOLT DIODES, 2 LEADS STYLE, DIODES W04X-13

DELCO
UNIVERSAL



D04-03
DELCO DIODE TRIO-ORANGE 10SI

ALLIS-CHALMERS	AMC	AUSTIN WESTERN
BOBCAT	BUICK	CADILLAC
33-100-1	D527	DT-01R
7127-12 7127-3	7127-6 7127-9	7134-12 7134-6
7134-6R 7134-9	7134-R 7137-12	7137-3 7137-6
1100109	1100110	1100111
1100113	1100115	1100119
1100120	1100121	1100122

STANDARD

3 AMP DIODES, ORANGE, 10SI, 12SI, 15SI, 17SI, ALTERNATE D04-02

DELCO
UNIVERSAL



D04-06
DELCO DIODE TRIO 17SI, 21SI

AGCO	BUHLER	BUICK
CADILLAC	CATERPILLAR	CHAMPION
33-101	D985	DT-10
7287-12 7287-3	7287-6 7287-9	7288-12 7288-9
7564 7565	7641 7642	7644 7659
1101215	1101252	1101258
1101290	1105585	1105613
1105656	1105658	1105680

61mm BOLT PATTERN

3 AMP DIODES, 17SI, 21SI

SEV MARCHAL



W044-01
SEV BUTTERFLY TRIO

HATZ	KHD	PORSCHE
14265 14280		
71214102	71233002	71314202

1.5 AMP, 100 VOLT DIODES, SINGLE LEAD STYLE, DIODES W04X-13.

DELCO
UNIVERSAL



D04-04
DELCO DIODE TRIO-40SI

CHEVROLET	CUMMINS	INTERNATIONAL
33-105	D572	
7239 7246	7250 7251	
1117141	1117142	1117143
1117144	1117145	1117146
1117147	1117148	1117149

3 AMP DIODES, 40SI

DELCO
UNIVERSAL



D04-07
DELCO DIODE TRIO 27SI

ALLIS-CHALMERS	AUSTIN WESTERN	AUTOCAR
BUICK	CADILLAC	CATERPILLAR
33-102	33-102-1	D1001
DT-06		
7135 7135M	7136 7138	7139 7157M
7160 7161	7197 7847	7850 7899
1100072	1100073	1100075
1100076	1100077	1100078
1100081	1100082	1100083

3 AMP DIODES, 27SI



DELCO UNIVERSAL



D04-08
DELCO DIODE TRIO 22SI

CHEVROLET	CUMMINS	FORD
FORD H.D.	FREIGHTLINER	INTERNATIONAL
33-108	DT-18	DT22
8070 8071 8076 8078	8072 8073 8079 8360	8074 8075 8361 8366
19010190 19020300 19020304	19010191 19020302 19020305	19010192 19020303 19020306

3 AMP DIODES, 22SI, WITH AUTO START

DELCO UNIVERSAL



D04-11
DELCO DIODE NEGATIVE-50DN

BLUE BIRD	CHEVROLET	INTERNATIONAL
PETERBILT		
32-104 DD-867D	837M	867D
7257 7258 7655 8352	7259 7260 8353 8354	7653 7654 8356 8357
1117661 1117670 1117675	1117665 1117672 1117677	1117667 1117673 1117678

3/8"-24 STUD MOUNT

150 AMP, 200 VOLT, NEGATIVE, 50DN, FOR POSITIVE SEE D04-12

MARELLI UNIVERSAL



W043-00
FIAT DIODE TRIO

FIAT	MASSEY FERGUSO	
12280 13131	13132 13137	
63303100 63303321 63303391	63303311 63303360 63303600	63303320 63303380 63303610

1/4" SPADE

1.5 AMP, 100 VOLT DIODES, W04X-13

DELCO UNIVERSAL



D04-09
1/4"-28 DIODE NEGATIVE 70A-200V

1120R	32-768	DD-1120R
-------	--------	----------

1/4-28 THREAD

70 AMP, 200 VOLT, NEGATIVE, COMMONLY USED IN LEECE NEVILLE AND SOME BATTERY CHARGERS

DELCO UNIVERSAL



D04-12
DELCO DIODE POSITIVE-50DN

BLUE BIRD	CHEVROLET	INTERNATIONAL
PETERBILT		
32-105 DD-866D	866D	866M
7257 7258 7655 8352	7259 7260 8353 8354	7653 7654 8356 8357
1117661 1117665 1117669	1117663 1117667 1117670	1117664 1117668 1117672

3/8"-24 STUD MOUNT

150 AMP, 200 VOLT, POSITIVE, 50DN, FOR NEGATIVE SEE D04-11

DUCELLIER
MARELLI
UNIVERSAL



W043-01
MARELLI DIODE TRIO

FIAT	FIAT-ALLIS	IVECO
33-9402 IX700-1	DT-08	IX699
12026 12580	14293 14294	14954
516021A 63305431 7564A	63305206 63306000 7565C	63305400 63306300 7567C

1/4" PUSH ON

1.5 AMP, 100 VOLT DIODES, WITH LEAD, MARELLI AND DUCELLIER, ALTERNATE W047-00

DELCO UNIVERSAL



D04-10
1/4-28 DIODE POSITIVE 70A-200V

1120	32-769	DD-1120P
------	--------	----------

1/4-28 THREAD

70 AMP, 200 VOLT, POSITIVE, COMMONLY USED IN LEECE NEVILLE AND SOME BATTERY CHARGERS

DELCO UNIVERSAL



D04-13
DELCO DIODE TRIO 33SI, 34SI, 35SI

FORD	FORD H.D.	FREIGHTLINER
INTERNATIONAL	KENWORTH	MACK
33-109	DT-16	DT182
8080 8081 8091 8092	8082 8083 8093 8094	8085 8090 8095 8096
19011150 19011153 19011156	19011151 19011154 19011157	19011152 19011155 19011158

62mm BOLT PATTERN

3 AMP DIODES, 33SI, 34SI, 35SI, 36SI SERIES

MARELLI UNIVERSAL



W043-02
MAGNET-MARELLI DIODE TRIO

LANDROVER		
IX633		
13726		
63321200 63321234	63321204 63321240	63321233

1.5 AMP, 100 VOLT, USED ON W063-05, W063-06 RECTIFIER



HITACHI UNIVERSAL



W045-02
HITACHI DIODE - NEGATIVE 30A 200V

HONDA ISUZU	INFINITI JOHN DEERE	INGERSOLL RAND KIA			
32-8102 8671	8631 DD-1065	8631-3			
12042 12112 13287 13334	12761 13273 13474 13533	13275 13564	13285 13636		
L170G-6320 LR140-721C LR150-714 11.75mm OD	LR1110-707F LR140-723 LR150-715	LR140-721B LR150-711 LR160-723			

30 AMP, 200 VOLT, NEGATIVE, FITS RECTIFIER W065-64, W065-68, W065-82, W065-172.

HITACHI UNIVERSAL



W045-05
HITACHI AVL DIODE - POSITIVE 50A 23V

AUDI ISUZU	HONDA MAZDA	INFINITI NISSAN			
32-8109	8660	DD-1070			
11009 11027 11165 12240	11119 11120 12536 13215	11121 13612	11163 13639		
L1100G-23201 L190G-33201 LR1100-705C 11.75mm OD	L1100G-4320 LR1100-704 LR1100-709B	L1100G-7320 LR1100-704B LR1100-711			

50 AMP, 23 VOLT AVALANCHE, POSITIVE, FOR NEGATIVE USE W045-04

MOTOROLA UNIVERSAL



W046-02
UNIVERSAL DIODE TRIO

T200

1.5 AMP, 100 VOLT UNIVERSAL DIODE TRIO

HITACHI UNIVERSAL



W045-03
HITACHI DIODE - POSITIVE 30A 200V

HONDA ISUZU	INFINITI JOHN DEERE	INGERSOLL RAND KIA			
32-8103 DD-1066	8630	8670			
12042 12112 13287 13334	12761 13273 13474 13533	13275 13564	13285 13636		
L170G-6320 LR140-721C LR150-714 11.75mm OD	LR1110-707F LR140-723 LR150-715	LR140-721B LR150-711 LR160-723			

30 AMP, 200 VOLT, POSITIVE, FITS RECTIFIER W065-64, W065-68, W065-82, W065-172.

HITACHI UNIVERSAL



W045-06
HITACHI DIODE - NEGATIVE 35A 200V

CHEVROLET ISUZU	HONDA ISUZU HD	INFINITI NISSAN			
32-8104 DD-1059	8641	8641-3			
12335 12336 13531 13642	13261 13329 13713 13825	13474 13477			
LR1100-702 LR1110-702 LR180-509C 11.75mm OD	LR1110-701 LR1110-703B LR180-510	LR1110-701B LR160-724 LR180-725			

35 AMP, 200 VOLT, NEGATIVE, FITS RECTIFIER W065-82, W065-94, W065-95, W065-171, W065-185, W065-192, RELATED TO POSITIVE W045-07

UNIVERSAL



W04X-00
SMALL BABY BUTTON DIODE 25A 200V

AGCO DEUTZ-FAHR	BPM DODGE	CHRYSLER LAMBORGHINI			
32-703 DD-5075	8125	DD-5065			
14990 14991 7546 7549	7024 7505	7509	7537		
11.201.463 16.905.654 3755407	1-121 3755404 3755411	1-122 3755406 3755413			

8.5mm OD, 6.2mm W

25 AMP - 200 VOLT, POLARITY MARKED, BABY BUTTON, SEE W04X-02, W04X-32

HITACHI UNIVERSAL



W045-04
HITACHI AVL DIODE - NEGATIVE 50A 23V

AUDI ISUZU	HONDA MAZDA	INFINITI NISSAN			
32-8108	8661	DD-1069			
11009 11027 11165 12240	11119 11120 12536 13215	11121 13612	11163 13639		
L1100G-23201 L190G-33201 LR1100-705C 11.75mm OD	L1100G-4320 LR1100-704 LR1100-709B	L1100G-7320 LR1100-704B LR1100-711			

50 AMP, 23 VOLT AVALANCHE, NEGATIVE, FOR POSITIVE USE W045-05

HITACHI UNIVERSAL



W045-07
HITACHI DIODE - POSITIVE 35A 200V

CHEVROLET ISUZU	HONDA ISUZU HD	INFINITI NISSAN			
32-8105 DD-1060	8640	8640-3			
12335 12336 13531 13642	13261 13329 13713 13825	13474 13477			
LR1100-702 LR1110-702 LR180-510 11.75mm OD	LR1110-701 LR160-724 LR180-725	LR1110-701B LR180-509C LR180-725B			

35 AMP, 200 VOLT, POSITIVE, FITS RECTIFIER W065-82, W065-94, W065-95, W065-171, W065-185, W065-192, RELATED TO NEGATIVE W045-06

UNIVERSAL



W04X-01
UNIVERSAL 3 AMP AXIAL DIODE

AGCO AUDI	ALFA ROMEO BAUDOIN MARINE	ATLAS BMW			
32-8905 GP30D	8030	DD-5404			
12110 12156 12390 12411	12174 12412	12301 12415	12302 12416	12381 12417	
0-120-400-627 0-120-400-634 0-120-400-690	0-120-400-629 0-120-400-643 0-120-400-712	0-120-400-631 0-120-400-644 0-120-400-714			

5.2mm OD, 6.2mm W

3 AMP, 100 VOLT, POLARITY MARKED



UNIVERSAL



W04X-03

1/2" DIODE - POSITIVE 35A 200V

ALLIS-CHALMERS	AMC	AUDI	
AUSTIN WESTERN	AUTOCAR	BAKER	
32-709	32-720	32-774	
8734	8760	8820	
13025	13030	13122	14003
14023	14038	14075	14076
14005	14010		
0-120-400-665	0-120-400-727	0-120-400-893	
0-120-400-894	0-120-469-514	0-120-469-515	
0-120-469-524	1100553	1100557	

35 AMP, 200 VOLT, POSITIVE, FOR NEGATIVE USE
W04X-04, ALTERNATE W04X-56

UNIVERSAL



W04X-06

1/2" DIODE - NEGATIVE 50A 200V 100ML

DODGE	FORD H.D.	FREIGHTLINER	
GRADALL	IH (INTERNATIONAL)	INTERNATIONAL	
32-710	8751	8753	
DD-1061			
14572	7611	8380	8426
8789			
71236002	8LHA2054UA	8MR2308UB	
8MR2401U	8MR2401UA	90753	
M06-07	W064-10		

50 AMP, 200 VOLT, NEGATIVE, FOR POSITIVE USE
W04X-05, ALTERNATE W04X-36

UNIVERSAL



W04X-11

1/2" DIODE - POSITIVE 25A 100V

ALFA ROMEO	BMW	JOHN DEERE	
MASERATI	MERCEDES	OPEL	
8724	DD-1013		
13001	13005	13008	13009
13015	13018	13025	7343
13012	13014	7456	
0-120-400-504	0-120-400-505	0-120-400-517	
0-120-400-522	0-120-400-523	0-120-400-528	
0-120-400-529	0-120-400-530	0-120-400-532	

25 AMP, 100 VOLT, POSITIVE, FOR NEGATIVE USE
W04X-12, ALTERNATE W04X-03

UNIVERSAL



W04X-04

1/2" DIODE - NEGATIVE 35A 200V

AUDI	AUSTIN WESTERN	CATERPILLAR	
CHEVROLET	CHRYSLER	CLARK	
32-708	32-719	32-773	
8735	8761	DD-1014	
13025	13030	13122	14003
14023	14038	14075	14076
14005	14010		
0-120-400-665	0-120-400-727	0-120-400-893	
0-120-400-894	0-120-469-514	0-120-469-515	
0-120-469-524	1117753	1117754	

35 AMP, 200 VOLT, NEGATIVE, FOR POSITIVE USE
W04X-03, ALTERNATE W04X-55

UNIVERSAL



W04X-07

5/16" TIN CAN DIODE - POSITIVE 25A 100V

DATSUN	FORD	HONDA	
MAZDA	MITSUI-DEUTZ	NISSAN	
32-702	8520	8524	
8650	9326	DD-1008	
14130	14151	14186	14194
14213	14500	14576	7068
7069			
021000-1320	021000-2252	021000-3050	
021000-5020	021000-5040	021000-5070	
021000-5080	021000-5130	021000-5230	

25 AMP, 100 VOLT, POSITIVE, FOR NEGATIVE USE
W04X-08

UNIVERSAL



W04X-12

1/2" DIODE - NEGATIVE 25A 100V

ALFA ROMEO	BMW	JOHN DEERE	
MASERATI	MERCEDES	OPEL	
32-706	8725	DD-1012	
13001	13005	13008	13009
13015	13018	13025	7343
13012	13014	7456	
0-120-400-504	0-120-400-505	0-120-400-517	
0-120-400-522	0-120-400-523	0-120-400-528	
0-120-400-529	0-120-400-530	0-120-400-532	

25 AMP, 100 VOLT, NEGATIVE, FOR POSITIVE USE
W04X-11, ALTERNATE W04X-04

UNIVERSAL



W04X-05

1/2" DIODE - POSITIVE 50A 200V 100ML

DODGE	FORD H.D.	FREIGHTLINER	
GRADALL	IH (INTERNATIONAL)	INTERNATIONAL	
32-711	8750	8752	
DD-1062			
14572	7611	8380	8426
8789			
71236002	8LHA2054UA	8MR2308UB	
8MR2401U	8MR2401UA	90753	
M06-06	W064-09		

50 AMP, 200 VOLT, POSITIVE, FOR NEGATIVE USE
W04X-06, ALTERNATE W04X-35

UNIVERSAL



W04X-08

5/16" TIN CAN DIODE - NEGATIVE 25A 100V

DATSUN	FORD	HONDA	
MAZDA	MITSUI-DEUTZ	NISSAN	
32-701	8521	8525	
8651	9325	DD-1007	
14130	14151	14186	14194
14213	14500	14576	7068
7069			
021000-1320	021000-2252	021000-3050	
021000-5020	021000-5040	021000-5070	
021000-5080	021000-5130	021000-5230	

25 AMP, 100 VOLT, NEGATIVE, FOR POSITIVE USE
W04X-07

UNIVERSAL



W04X-13

UNIVERSAL 1.5 AMP AXIAL DIODE

ACURA	AGCO	BEDFORD	
BPM	CATERPILLAR	CHEVROLET	
32-8904	8015	9215	
9410	DD-5393	GP15D	
12042	12097	12105	12108
12113	12115	12118	12119
12109	12112	12136	
100211-0080	11.201.463	16.905.654	
61920025	61920045	61920166	
8AL2034K	8AL2057K	9FB2LD2A07	

1.5 AMP, 200 VOLT, UNIVERSAL POLARITY MARKED,
FOR 3 AMP DIODE USE W04X-01



UNIVERSAL



W04X-14
DISH DIODE - POSITIVE 25A 400V

ALLIS-CHALMERS DEUTZ-ALLIS	CHEVROLET GEO	DAIHATSU HONDA	
32-8902 DD-1041	32-8910	7220	
12105 12113 12129 12278	12114 12115 13240 13383	12117 12118 13414 14255	
100211-1201 100211-1271 100211-1341	100211-1212 100211-1321 100211-1361	100211-1224 100211-1331 100211-1381	

8.4mm OD

25 AMP, 400 VOLT, POSITIVE, FOR NEGATIVE USE
W04X-15, ALTERNATE W04X-60, W04X-62

UNIVERSAL



W04X-15N
DISH DIODE - NEGATIVE 20A 200V

ACURA CHEVROLET	BOMBARDIER CLARK	CATERPILLAR DAIHATSU	
7221			
12080 12097 12182 12183	12108 12109 12186 12188	12115 12126 12189 12190	
100211-1001 100211-1041 100211-1080	100211-1030 100211-1050 100211-1081	100211-1031 100211-1061 100211-1091	

8.4mm OD

20 AMP, 200 VOLT, NEGATIVE, FOR POSITIVE USE
W04X-14N, MADE IN JAPAN

UNIVERSAL



W04X-19
DISH DIODE - NEGATIVE 35A 400V

CHRYSLER ISUZU	DODGE JEEP	EAGLE LEXUS	
32-8901 7231	32-8917 DD-1042	7201A	
13169 13308 13389 13394	13323 13331 13407 13443	13354 13384 13537 13558	
100211-0090 100211-0330 100211-0540	100211-0240 100211-0500 100211-0550	100211-0270 100211-0530 100211-0560	

9.7mm OD

35 AMP, 400 VOLT, NEGATIVE, FOR POSITIVE USE
W04X-18

UNIVERSAL



W04X-14N
DISH DIODE - POSITIVE 20A 200V

ACURA CHEVROLET	BOMBARDIER CLARK	CATERPILLAR DAIHATSU	
7220			
12080 12097 12182 12183	12108 12109 12186 12188	12115 12126 12189 12190	
100211-1001 100211-1041 100211-1080	100211-1030 100211-1050 100211-1081	100211-1031 100211-1061 100211-1091	

8.4mm OD

20 AMP, 200 VOLT, POSITIVE, FOR NEGATIVE USE
W04X-15N, MADE IN JAPAN

UNIVERSAL



W04X-18
DISH DIODE - POSITIVE 35A 400V

CHRYSLER ISUZU	DODGE JEEP	EAGLE LEXUS	
32-8900 7230	32-8918 DD-1043	7200A	
13169 13308 13389 13394	13323 13331 13407 13443	13354 13384 13537 13558	
100211-0090 100211-0330 100211-0540	100211-0240 100211-0500 100211-0550	100211-0270 100211-0530 100211-0560	

9.7mm OD

35 AMP, 400 VOLT, POSITIVE, FOR NEGATIVE USE
W04X-19

UNIVERSAL



W04X-19N
DISH DIODE - NEGATIVE 30A 200V

ACURA CHRYSLER	CATERPILLAR DAIHATSU	CHEVROLET DODGE	
32-8917	7231		
11031 11089 11533 11837	11094 11100 12192 12208	11116 11117 12234 12235	
021580-4850 100211-3120 100211-6170	100211-1071 100211-6060 100211-6360	100211-1371 100211-6110 100211-6390	

9.7mm OD

30 AMP, 200 VOLT, NEGATIVE, FOR POSITIVE USE
W04X-18N

UNIVERSAL



W04X-15
DISH DIODE - NEGATIVE 25A 400V

ALLIS-CHALMERS DEUTZ-ALLIS	CHEVROLET GEO	DAIHATSU HONDA	
32-8903 7221	32-8909 D221	7201 DD-1040	
12105 12113 12129 12278	12114 12115 13240 13383	12117 12118 13414 14255	
100211-1201 100211-1271 100211-1341	100211-1212 100211-1321 100211-1361	100211-1224 100211-1331 100211-1381	

8.4mm OD

25 AMP, 400 VOLT, NEGATIVE, FOR POSITIVE USE
W04X-14, ALTERNATE W04X-59, W04X-61

UNIVERSAL



W04X-18N
DISH DIODE - POSITIVE 30A 200V

ACURA CHRYSLER	CATERPILLAR DAIHATSU	CHEVROLET DODGE	
32-8918	7230		
11031 11089 11533 11837	11094 11100 12192 12208	11116 11117 12234 12235	
021580-4850 100211-3120 100211-6170	100211-1071 100211-6060 100211-6360	100211-1371 100211-6110 100211-6390	

9.7mm OD

30 AMP, 200 VOLT, POSITIVE, FOR NEGATIVE USE
W04X-19N, MADE IN JAPAN

UNIVERSAL



W04X-20
BUTTON DIODE - POSITIVE 25A 100V

32-712	8610
--------	------

10mm OD, 1" STEM

25 AMP, 100 VOLT - POSITIVE, FOR NEGATIVE USE
W04X-21



UNIVERSAL



W04X-21
BUTTON DIODE - NEGATIVE 25A 100V

32-713	8611
--------	------

10mm OD, 1" STEM

25 AMP, 100 VOLT - NEGATIVE, FOR POSITIVE USE W04X-20

MANDO
MITSUBISHI
UNIVERSAL



W04X-24
MITSUBISHI SQUARE DIODE-POSITIVE 30A 200V

ACURA	BOBCAT	CASE
CATERPILLAR	CHEVROLET	CHRYSLER

32-8300	8330	DD-5028
---------	------	---------

11029	11055	11057	11058	11095	11118
11176	11317	11558	12077	12136	12138
0206-102-0110	0206-102-0211	2656068			
A002TG1891	A0T25471	A1T01991			
A1T02291	A1T02592	A1T02674			

LOW PROFILE

30 AMP, 200 VOLT, POSITIVE, FOR NEGATIVE USE W04X-25

BOSCH
UNIVERSAL



W04X-29
BOSCH 1/2" DIODE - POSITIVE 35A 200V

AGCO	AIFO	AKERMAK
ALFA ROMEO	ATLAS	AUDI

32-9101	8234	8236
8710	DD-1023	

12048	12049	12102	12110	12134	12156
12161	12301	12302	12411	12412	12415
0-120-400-600	0-120-400-604	0-120-400-605			
0-120-400-606	0-120-400-608	0-120-400-609			
0-120-400-611	0-120-400-614	0-120-400-620			

12.8mm(1/2") OD

35 AMP, 200 VOLT, POSITIVE, PRESSED IN FROM THE BACK TO THE BOSCH BASE RIM, FOR NEGATIVE USE W04X-28

LUCAS
UNIVERSAL



W04X-22
LUCAS DIODE - POSITIVE 35A 200V

CASE	FORD	FORD AG
IH (INTERNATIONAL	J.C. BAMFORD	JAGUAR

32-9201	9224	9226
9230	DD-1039	

12038	12040	12041	12045	12046	12047
12072	12073	12074	12089	12090	12091
23970A/B	23971A	23996A			
24011A	24037A/B	24049A			
24055A/B	24056A/B	24061A/B			

10mm OD, 1" STEM

35 AMP, 200 VOLT, POSITIVE, FOR NEGATIVE USE W04X-23, REPAIRS RECTIFIER W061-06

MANDO
MITSUBISHI
UNIVERSAL



W04X-25
MITSUBISHI SQUARE DIODE-NEGATIVE 30A 200V

ACURA	BOBCAT	CASE
CATERPILLAR	CHEVROLET	CHRYSLER

32-8301	8331	DD-5027
---------	------	---------

11029	11055	11057	11058	11095	11118
11176	11317	11558	12077	12136	12138
0206-102-0110	0206-102-0211	2656068			
A002TG1891	A0T25471	A1T01991			
A1T02291	A1T02592	A1T02674			

LOW PROFILE

30 AMP, 200 VOLT, NEGATIVE, FOR POSITIVE USE W04X-24

UNIVERSAL



W04X-30
5/16" TIN CAN DIODE - POSITIVE 35A 400

CASE	GMC	HINO
IH (INTERNATIONAL	ISUZU	TOYOTA

32-724	8534	DD-1076
--------	------	---------

12003	12016	12083	12084	12132	14130
14150	14461	14737			
021000-0520	021000-3660	021600-1980			
100211-1721	100211-2570	100211-2980			
100211-2990	100211-5760	100211-5930			

5/16" OD, FORKED LEAD

35 AMP, 400 VOLT, POSITIVE, FOR NEGATIVE USE W04X-31, ALTERNATE W04X-07 STRAIGHT LEAD

LUCAS
UNIVERSAL



W04X-23
LUCAS DIODE - NEGATIVE 35A 200V

CASE	FORD	FORD AG
IH (INTERNATIONAL	J.C. BAMFORD	JAGUAR

32-9200	9225	9231
DD-1038		

12038	12040	12041	12045	12046	12047
12072	12073	12074	12089	12090	12091
23970A/B	23971A	23996A			
24011A	24037A/B	24049A			
24055A/B	24056A/B	24061A/B			

10mm OD, 1" STEM

35 AMP, 200 VOLT, NEGATIVE, FOR POSITIVE USE W04X-22, REPAIRS RECTIFIER W061-06

BOSCH
UNIVERSAL



W04X-28
BOSCH 1/2" DIODE - NEGATIVE 35A 200V

AGCO	AIFO	AKERMAK
ALFA ROMEO	ATLAS	AUDI

32-9100	8235	DD-1022
---------	------	---------

12048	12049	12102	12110	12134	12156
12161	12297	12301	12302	12411	12412
0-120-400-600	0-120-400-604	0-120-400-605			
0-120-400-606	0-120-400-608	0-120-400-609			
0-120-400-611	0-120-400-614	0-120-400-620			

12.8mm(1/2") OD

35 AMP, 200 VOLT, NEGATIVE, PRESSED IN FROM THE BACK TO THE BOSCH BASE RIM, FOR POSITIVE USE W04X-29

UNIVERSAL



W04X-31
5/16" TIN CAN DIODE - NEGATIVE 35A 400V

CASE	GMC	HINO
IH (INTERNATIONAL	ISUZU	TOYOTA

32-723	8535	DD-1075
--------	------	---------

12003	12016	12083	12084	12132	14130
14150	14461	14737			
021000-0520	021000-3660	021600-1980			
100211-1721	100211-2570	100211-2980			
100211-2990	100211-5760	100211-5930			

5/16" OD, FORKED LEAD

35 AMP, 400 VOLT, NEGATIVE, FOR POSITIVE USE W04X-30, ALTERNATE W04X-08 STRAIGHT LEAD



UNIVERSAL



W04X-32
SMALL BABY BUTTON DIODE 50A 200V

32-735	8150
--------	------

8.5mm OD, 6.2mm W

50 AMP, 200 VOLT, POLARITY MARKED, 25A VERSION W04X-00

UNIVERSAL



W04X-35
1/2" DIODE - POSITIVE 70A 200V 100ML

FORD MACK	FREIGHTLINER PETERBILT	INTERNATIONAL VOLVO HD
32-788 DD-1126	8770	8772
7612 7632 8337 8342	7640 7661 8349	7763 7767
2670JB 4725JA 7700JA	2700J 4750J 7702JA	4725A 4834LC 7704JA

12.8mm OD, 100 MIL LEAD

70 AMP, 200 VOLT, POSITIVE, FOR NEGATIVE USE W04X-36

BOSCH
UNIVERSAL



W04X-40
BOSCH 1/2" AVL DIODE - POSITIVE 50A 22V

ALFA ROMEO CADILLAC	AUDI CASE	BMW FIAT
32-9103	8454	DD-1054
12161 12671 13376 13380	12672 13356 13381 13382	13357 13359 13417 13422
0-120-465-006 0-120-465-020 0-120-465-028	0-120-465-007 0-120-465-021 0-120-465-031	0-120-465-017 0-120-465-026 0-120-485-022

12.8mm(1/2") OD

50 AMP, 23-32 VOLT AVALANCHE, POSITIVE, PRESSED IN FROM THE BACK TO THE BOSCH BASE RIM, SET WITH W04X-39

DELCO
UNIVERSAL



W04X-33
1/2" DELCO DIODE - NEGATIVE 25A 200V

ALLIS-CHALMERS BAKER	AMC BUICK	AUSTIN WESTERN CADILLAC
32-100 DD-1001	32-107	8961
12280 13075 7113 7116	7106 7107 7117 7122	7109 7111 7141 7143
1100059 1100064 1100067	1100062 1100065 1100068	1100063 1100066 1100071

1/2" OD

25 AMP, 200 VOLT, NEGATIVE, FOR POSITIVE USE W04X-34, ALTERNATE W04X-49

UNIVERSAL



W04X-36
1/2" DIODE - NEGATIVE 70A 200V 100ML

FORD MACK	FREIGHTLINER PETERBILT	INTERNATIONAL VOLVO HD
32-787 DD-1125	8771	8773
7612 7632 8337 8342	7640 7661 8349	7763 7767
2670JB 4725JA 7700JA	2700J 4750J 7702JA	4725A 4834LC 7704JA

12.8mm OD, 100 MIL LEAD

70 AMP, 200 VOLT, NEGATIVE, FOR POSITIVE USE W04X-35

BOSCH
UNIVERSAL



W04X-41
1/2" DIODE - NEGATIVE 70A 200V FLUSH

FORD	LINCOLN	MERCURY
32-1060913	8271	
7795 8253	8315	
3W1U-10300-BB F8AU-10300-AC XF2U-10300-BC	F06-06HD F8AU-10300-AD	F8AU-10300-AB WR2A-10300-AC

12.8mm(1/2") OD

70 AMP, 200 VOLT, NEGATIVE, PRESSED IN FLUSH FROM THE BACK, FOR POSITIVE USE W04X-42

DELCO
UNIVERSAL



W04X-34
1/2" DELCO DIODE - POSITIVE 25A 200V

ALLIS-CHALMERS BAKER	AMC BUICK	AUSTIN WESTERN CADILLAC
32-101 DD-1002	32-108	8960
12280 13075 7113 7116	7106 7107 7117 7122	7109 7111 7141 7143
1100059 1100064 1100067	1100062 1100065 1100068	1100063 1100066 1100071

1/2" OD

25 AMP, 200 VOLT, POSITIVE, FOR NEGATIVE USE W04X-33

BOSCH
UNIVERSAL



W04X-39
BOSCH 1/2" AVL DIODE - NEGATIVE 50A 22V

ALFA ROMEO CADILLAC	AUDI CASE	BMW FIAT
32-9102	8455	DD-1053
12161 12671 13376 13380	12672 13356 13381 13382	13357 13359 13417 13422
0-120-465-006 0-120-465-020 0-120-465-028	0-120-465-007 0-120-465-021 0-120-465-031	0-120-465-017 0-120-465-026 0-120-485-022

12.8mm(1/2") OD

50 AMP, 23-32 VOLT AVALANCHE, NEGATIVE, PRESSED IN FROM THE BACK TO THE BOSCH BASE RIM, SET WITH W04X-40, BOSCH AND VALEO

BOSCH
UNIVERSAL



W04X-42
1/2" DIODE - POSITIVE 70A 200V FLUSH

FORD	LINCOLN	MERCURY
32-1060912	8270	
7795 8253	8315	
1-005-831-897 F8AU-10300-AB WR2A-10300-AC	3W1U-10300-BB F8AU-10300-AC XF2U-10300-BC	F06-06HD F8AU-10300-AD

12.8mm(1/2") OD

70 AMP, 200 VOLT, POSITIVE, PRESSED IN FLUSH FROM THE BACK, FOR NEGATIVE USE W04X-41



BOSCH
UNIVERSAL



W04X-43

1/2" AVL DIODE - NEGATIVE 50A 39V FLUSH

CUMMINS	DAF	EL DETALLE			
IVECO	JOHN DEERE	KHD			
8467	DD-1091				
12387	12389	12493	12591	12594	12599
12724	12793	12811	12812	23833	23868
0-124-555-001	0-124-555-002	0-124-555-004			
0-124-555-005	0-124-555-006	0-124-555-007			
0-124-555-008	0-124-555-009	0-124-555-011			
12.8mm(1/2") OD					

50 AMP, 39 VOLT AVALANCHE, NEGATIVE, USED ON 24 VOLT SYSTEMS, PRESSED IN FLUSH FROM THE BACK, POSITIVE W04X-44

BOSCH
UNIVERSAL



W04X-46

1/2" DIODE - POSITIVE 50A 400V FLUSH

BMW	DODGE	FORD			
FORD H.D.	LINCOLN	MAZDA			
32-200	8252	8254			
DD-1037					
11235	11239	11314	13235	13363	13604
13843	13920	13987	14782	14791	14812
0-120-468-009	0-120-468-010	0-120-468-011			
0-120-468-012	0-120-468-015	0-120-468-016			
0-120-468-057	0-120-468-058	0-120-468-059			
12.8mm(1/2") OD					

50 AMP, 400 VOLT, POSITIVE, PRESSED IN FLUSH FROM THE BACK, FOR NEGATIVE USE W04X-45

DELCO
UNIVERSAL



W04X-49

1/2" DIODE - NEGATIVE 35A 200V 10DN

AUTOCAR	CATERPILLAR				CHEVROLET	
CUMMINS	DETROIT				FORD	
32-102	8981				DD-1003	
7237	7241	7245	7252	7254	7255	
7649	7657	7674	7675	8060	8061	
1117069	1117155				1117167	
1117225	1117226				1117227	
1117228	1117229				1117231	
1/2" OD						

35 AMP, 200 VOLT, NEGATIVE, FOR POSITIVE USE W04X-50, SEE W04X-33 25A 200V

BOSCH
UNIVERSAL



W04X-44

1/2" AVL DIODE - POSITIVE 50A-39V FLUSH

CUMMINS	DAF	EL DETALLE			
IVECO	JOHN DEERE	KHD			
32-1060102	8466	DD-1092			
12387	12389	12493	12591	12594	12599
12724	12793	12811	12812	23515	23833
0-124-555-001	0-124-555-002	0-124-555-004			
0-124-555-005	0-124-555-006	0-124-555-007			
0-124-555-008	0-124-555-009	0-124-555-011			
12.8mm(1/2") OD					

50 AMP, 39 VOLT AVALANCHE, POSITIVE, USED ON 24 VOLT SYSTEMS, PRESSED IN FLUSH FROM THE BACK, NEGATIVE W04X-43

UNIVERSAL



W04X-47

9.7mm DISH DIODE - NEGATIVE 50A 400V

CHRYSLER	DODGE	PLYMOUTH			
TOYOTA					
32-8921	DD-1071				
13741	13765	13766	13824	13842	13859
13911	13964				
102211-0610	121000-4260	121000-4270			
121000-4280	121000-4290	121000-4331			
121000-4351	121000-4372	121000-4373			
9.7mm OD, 23mm L					

50 AMP, 400 VOLT, NEGATIVE, FOR POSITIVE USE W04X-48

DELCO
UNIVERSAL



W04X-50

1/2" DIODE - POSITIVE 35A 200V 10DN

AUTOCAR	CATERPILLAR				CHEVROLET	
CUMMINS	DETROIT				FORD	
32-103	8980				DD-1004	
7237	7241	7245	7252	7254	7255	
7649	7657	7674	7675	8060	8061	
1117069	1117155				1117167	
1117225	1117226				1117227	
1117228	1117229				1117231	
1/2" OD						

35 AMP, 200 VOLT, POSITIVE, FOR NEGATIVE USE W04X-49, SEE W04X-34 25A 200V

BOSCH
UNIVERSAL



W04X-45

1/2" DIODE - NEGATIVE 50A 400V FLUSH

BMW	DODGE	FORD			
FORD H.D.	LINCOLN	MAZDA			
32-201	32-203-1	8253			
8255	DD-1036				
11235	11239	11314	13235	13363	13604
13843	13920	13987	14782	14791	14812
0-120-468-009	0-120-468-010	0-120-468-011			
0-120-468-012	0-120-468-015	0-120-468-016			
0-120-468-057	0-120-468-058	0-120-468-059			
12.8mm(1/2") OD					

50 AMP, 400 VOLT, NEGATIVE, PRESSED IN FLUSH FROM THE BACK, FOR POSITIVE USE W04X-46

UNIVERSAL



W04X-48

9.7mm DISH DIODE - POSITIVE 50A 400V

CHRYSLER	DODGE	PLYMOUTH			
TOYOTA					
32-8922	DD-1072				
13741	13765	13766	13824	13842	13859
13911	13964				
102211-0610	121000-4260	121000-4270			
121000-4280	121000-4290	121000-4331			
121000-4351	121000-4372	121000-4373			
9.7mm OD, 23mm L					

50 AMP, 400 VOLT, POSITIVE, FOR NEGATIVE USE W04X-47

BOSCH
UNIVERSAL



W04X-51

1/2" AVL DIODE - NEGATIVE 50A-22V FLUSH

AUDI	BLUE BIRD				BMW	
BOBCAT	BUICK				CADILLAC	
DD-1063						
11011	11014	11015	11016	11017	11018	
11019	11020	11021	11022	11023	11041	
0-121-615-002	0-121-615-003	0-121-615-005				
0-121-615-008	0-121-615-010	0-121-615-011				
0-121-615-012	0-121-615-014	0-121-615-016				
12.8mm(1/2") OD						

50 AMP, 22 VOLT AVALANCHE, NEGATIVE, PRESSED IN FLUSH FROM THE BACK, FOR POSITIVE USE W04X-52



BOSCH
UNIVERSAL



W04X-52
1/2" AVL DIODE - POSITIVE 50A-22V FLUSH

AUDI	BLUE BIRD	BMW
BOBCAT	BUICK	CADILLAC

DD-1064

11011	11014	11015	11016	11017	11018
11019	11020	11021	11022	11023	11041
0-121-615-002	0-121-615-003	0-121-615-005			
0-121-615-008	0-121-615-010	0-121-615-011			
0-121-615-012	0-121-615-014	0-121-615-016			

12.8mm(1/2") OD

50 AMP, 22 VOLT AVALANCHE, POSITIVE, PRESSED IN FLUSH FROM THE BACK, FOR NEGATIVE USE W04X-51

UNIVERSAL



W04X-55
1/2" DIODE - NEGATIVE 50A 400V

DD-1026

12.8mm(1/2") OD

50 AMP, 400 VOLT, NEGATIVE, FOR POSITIVE USE W04X-56

UNIVERSAL



W04X-58N
DISH DIODE - POSITIVE 35A 22V AVAL

PONTIAC	SCION	SUZUKI
TOYOTA		

11085	11086	11164	11194	11203	11505
13706	13878	13879	13958		
102211-0650	102211-1920	102211-1990			
102211-2000	102211-2480	102211-2610			
102211-9070	104210-8110	104210-8120			

9.5mm OD, 19.5mm OAL

35 AMP 22 VOLT AVALANCHE DIODE, FOR NEGATIVE DIODE USE W04X-57N

BOSCH
UNIVERSAL



W04X-53
1/2" AVL DIODE - NEGATIVE 70A-22V FLUSH

AGCO	AUDI	BMW
CASE	CATERPILLAR	CHAMPION

32-1080201 DD-1089

11067	11068	11074	11078	11079	11080
11081	11083	11216	11217	11257	11262
0-122-0AA-090	0-122-0AA-0B0	0-122-0AA-0D0			
0-122-0AA-0R0	0-122-0AA-140	0-122-0AA-160			
0-122-0AA-1A0	0-122-0AA-1D0	0-122-0AA-1H0			

12.8mm(1/2") OD

70 AMP, 22 VOLT AVALANCHE, NEGATIVE, PRESSED IN FLUSH FROM THE BACK, FOR POSITIVE USE W04X-54

UNIVERSAL



W04X-56
1/2" DIODE - POSITIVE 50A 400V

DD-1027

12.8mm(1/2") OD

50 AMP, 400 VOLT, POSITIVE, FOR NEGATIVE USE W04X-55

UNIVERSAL



W04X-59
8.4mm DISH DIODE - NEGATIVE 35A 400V

32-8919 DD-1085

8.4mm OD, 23mm LONG

35 AMP, 400 VOLT, NEGATIVE. FOR POSITIVE USE W04X-60. ALTERNATE W04X-61

BOSCH
UNIVERSAL



W04X-54
1/2" AVL DIODE - POSITIVE 70A-22V FLUSH

AGCO	AUDI	BMW
CASE	CATERPILLAR	CHAMPION

32-1080200 DD-1090

11067	11068	11074	11078	11079	11080
11081	11083	11216	11217	11257	11262
0-122-0AA-090	0-122-0AA-0B0	0-122-0AA-0D0			
0-122-0AA-0R0	0-122-0AA-140	0-122-0AA-160			
0-122-0AA-1A0	0-122-0AA-1D0	0-122-0AA-1H0			

12.8mm(1/2") OD

70 AMP, 22 VOLT AVALANCHE, POSITIVE, PRESSED IN FLUSH FROM THE BACK, FOR NEGATIVE USE W04X-53

UNIVERSAL



W04X-57N
DISH DIODE - NEGATIVE 35A 22V AVAL

PONTIAC	SCION	SUZUKI
TOYOTA		

11085	11086	11164	11194	11203	11505
13706	13878	13879	13958		
102211-0650	102211-1920	102211-1990			
102211-2000	102211-2480	102211-2610			
102211-9070	104210-8110	104210-8120			

9.5mm OD, 23.5mm OAL

35 AMP 22 VOLT AVALANCHE DIODE, FOR POSITIVE USE W04X-58N

UNIVERSAL



W04X-60
8.4mm DISH DIODE - POSITIVE 35A 400V

DD-1086

8.4mm OD, 18mm L

35 AMP, 400 VOLT, POSITIVE, FOR NEGATIVE USE W04X-59. ALTERNATE W04X-62



UNIVERSAL



W04X-61

8.4mm DISH DIODE - NEGATIVE 50A 400V

DD-1111

8.4mm OD, 23mm L

50 AMP, 400 VOLT, NEGATIVE, FOR POSITIVE USE
W04X-62

VALEO



W042-01

PARIS RHONE DIODE TRIO

PEUGEOT

33-9400

14584 14955

A14R35 A14R41

1/4" SPADE

3 AMP DIODES, 82 OHM RESISTOR, FOR DIODES USE
W04X-01

UNIVERSAL



W04X-62

8.4mm DISH DIODE - POSITIVE 50A 400V

DD-1112

8.4mm OD, 18mm L

50 AMP, 400 VOLT, POSITIVE, FOR NEGATIVE USE
W04X-61

VALEO



W042-02

PARIS RHONE DIODE TRIO

PEUGEOT

TALBOT

A13R203 A13R220 A13R262

1.5 AMP, 100 VOLT DIODES, W04X-13

VALEO



W042-00

PARIS RHONE DIODE TRIO

ALFA ROMEO CITROEN PEUGEOT

14310 14565 14566

A13R121 A13R169 A13R170
A13R173 A13R184 A13R187
A13R219 A13R223 A13R265

DIODES W04X-13, ***NLA WHEN STOCK DEPLETED***

VALEO



W042-03

PARIS RHONE DIODE TRIO

PORSCHE RENAULT SCANIA

12709 14892

A14N180 A14N205 A14N67

3 AMP, 100 VOLT DIODES

Disclaimer

Wagner Alternators & Supplies, Inc. shall have neither liability nor responsibility to any person or entity with respect to loss and/or damages caused or alleged to be caused directly or indirectly by information contained in this catalog or any other Wagner Alternators & Supplies, Inc. publication, web site or sales representative.

The user acknowledges that they assume all risk and/or responsibility for any loss or damage arising from the uses to which the information provided by this catalog. Every effort has been made to make this information as complete and accurate as possible. However, there may be mistakes both typographical and in content. The information herein has been obtained through reliable sources and to the best of our knowledge is correct in content.

Any original equipment manufacturers or other manufacturers, or distributors, whose names, numbers, pictures, symbols, products and/or descriptions are, or may be, listed or shown are used for reference purposes only and there is no representation made or intended, nor implied that any item reference herein is the product of, or was manufactured and/or distributed, by, the referenced manufacturer or distributor. This catalog does not recommend any particular brand or product and no endorsements are implied. All company names and their products herein are covered by Copyright or Registered Trade Marks. Any use of them can lead to legal action.

Notice

All rights are reserved. Copies of information, product flyers and catalogs may be printed only for use in the normal course of business, and only for in-house use. No copies, reprints, reproductions, digital scanning, recording, distribution or publishing of any materials found on this site are permitted without the express written permission from Wagner Alternators & Supplies, Inc.

Prepared in U.S.A.

Copyright © 2017 by Wagner Alternators & Supplies, Inc.